



**f.rager.**  
magnetude® façade®  
PATENTED TECHNOLOGY

accessoires

**DB01**

**intro**

# accessoires

Frager is sinds jaar en dag dé absolute trendsetter op het vlak van deurpanelen.

Actuele trends in architectuur en interieur inspireren ons al meer dan 40 jaar om onze klanten telkens nét dat tikkeltje meer te kunnen bieden...

Met deze 'accessoires'-folder trekken we de lijn van innovatie verder door in ons gamma deurbeslag.

Meer dan ooit kiezen mensen bewust net die ene deurgreep die het ultieme sluitstuk vormt van hun deur en die deze volledig in haar kracht zet.

Soms zeer discreet ingewerkt, soms een echte architecturale eyecatcher maar altijd met respect voor de specifieke architectuur van de woning.

We zijn dan ook bijzonder fier op de vele nieuwigheden in deze folder. Binnen dit vernieuwde gamma vindt u ongetwijfeld voor elke deur de optimale afwerking.

## EEN OVERZICHT VAN DE VOORNAAMSTE NIEUWIGHEDEN

- Volledig gamma inox deurgrepen nu ook verkrijgbaar in poederlakuitvoering : naast een standaard zwart worden alle inox artikelen nu ook in alle denkbare poederlakkleuren aangeboden
- Forms: homemade deurgrepen met elegant geïntegreerde led-verlichting
- Plates: ongeëvenaard gedurfde geometrische designs
- Opwaardering van het gamma klassiek, landelijk beslag

Contacteer ons gerust voor bijkomende info !

Frager est depuis longtemps le précurseur absolu en matière de panneaux de porte.

Les tendances actuelles en matière d'architecture et d'aménagement intérieur nous incitent depuis plus de 40 ans à offrir chaque fois un peu plus à nos clients...

Avec cette brochure "accessoires", nous poursuivons la ligne d'innovation de notre gamme de poignées de porte.

Plus que jamais, les gens choisissent consciemment la poignée de porte qui constitue la pièce de fermeture ultime de leur porte et lui donne toute sa puissance.

Parfois très discrètement intégrée, parfois véritable accroche architecturale, mais toujours dans le respect de l'architecture spécifique de la maison.

Nous sommes donc particulièrement fiers des nombreuses nouveautés présentées dans cette brochure. Dans cette gamme renouvelée, vous trouverez sans aucun doute la finition optimale pour chaque porte.

## APERÇU DES PRINCIPALES NOUVEAUTÉS

- Gamme complète de poignées de porte en acier inoxydable désormais également disponibles en thermolaquage : outre le noir standard, tous les articles en acier inoxydable sont désormais également disponibles dans toutes les couleurs thermolaquées possibles et imaginables.
- Formes : poignées de porte artisanales avec éclairage LED élégamment intégré.
- Plaques : motifs géométriques audacieux inégalés
- Amélioration de la gamme classique de style campagnard

N'hésitez pas à nous contacter si vous souhaitez obtenir de plus amples informations !

## TREKKERS TIRANTS

DB2022	37
DB2023	37
DB2024	37
DB2025	37
DB2120 *	21
DB2123 *	21
DB2124 *	21
DB2125 *	22
DB2126 *	22
DB2127 *	22
DB2128 *	22
DB2131 *	23
DB2132 *	23
DB2133 *	23
DB2134 *	24
DB2135 *	24
DB2136 *	24
DB2140 *	24
DB2141 *	24
DB2142 *	24
DB2143 *	29
DB2152 *	25
DB2153 *	25
DB2154 *	25
DB2211	16
DB2212	16
DB2221	31
DB2222	31
DB2224 *	26
DB2225 *	26
DB2226 *	26
DB2227 *	26
DB2250 *	26
DB2251 *	26

DB2252 *	26
DB2253 *	26
DB2254 *	26
DB2255 *	26
DB2256 *	27
DB2257 *	27
DB2259 *	27
DB2260 *	27
DB2261 *	27
DB2262 *	27
DB2263 *	26
DB2264 *	26
DB2265 *	27
DB2266 *	27
DB2290 *	30
DB2291 *	30
DB2292	28
DB2293	28
DB2294	29
DB2295	29
DB2370	7
DB2371	8
DB2717	34
DB2721	31
DB2722	31
DB2790 *	30
DB2791 *	30
DB2811	32
DB2813	32
DB2816	32
DB2817	32
DB2818	32
DB2821	32
DB2860	32
DB2861	32

DB2911	33
DB2913	33
DB2914	33
DB2916	34
DB2917	34
DB2918	36
DB2921	36
DB2950/DB2850	35
DB2951/DB2851	35
DB2952/DB2852	35
DB2960	36
DB2961	36

## FORMS

DB2001	39
DB2002	39
DB2003	39
DB2004	39
DB2005	39
DB2006	39
DB2007	39
DB2008	39

## PLATES

DB2009	40
DB2010	40
DB2011	41
DB2012	41
DB2013	40
DB2014	40
DB2015	41
DB2016	41

## DEURKRUKKEN

### POIGNÉES DE PORTES

DB1215	29
DB1216	29
DB1359	15
DB1360	15
DB1363	16

## CILINDERPLAAT

### CACHE CYLINDRE

DB3201	29
DB3202	29
DB3342	9
DB3356	15
DB3362	16

## BRIEVENBUS

### BOÎTE AUX LETTRES

DB4355	18
DB4357	18

## SPIONOOG

### WISEUR OPTIQUE

DB6029	29
--------	----



## MONTAGE-INSTRUCTIES

### INSTRUCTIONS DE MONTAGE

## ONDERHOUD

### ENTRETIEN

<b>VT</b>	verouderde tinkleur couleur étain vieilli
<b>VZ</b>	verouderd zwart noir vieilli
<b>RK</b>	rood koper cuivre rouge
<b>VB</b>	verouderde bronskleur bronze vieilli
<b>SN</b>	tin étain
<b>ZW</b>	zwart noir Axalta SD30C - 49005 - 20

<b>IN</b>	inox
<b>PL</b>	poederlak RAL poudre
	trekker met een unieke, ambachtelijke textuur tirant avec une texture artisanale unique
	maatwerk mogelijk possible sur mesure
*	geschikt voor blinde of paarsgewijze bevestiging adapté pour montage aveugle ou en paire



Voortaan zijn de inox grepen aangeduid met **PL** ook mogelijk in poederlak (mat / blinkend / structuur)

Il est désormais possible d' avoir les tirants inox indiqués avec **PL** en finition thermolaqué (mat / brillant / structuré)



# accessoires



DB2370VT

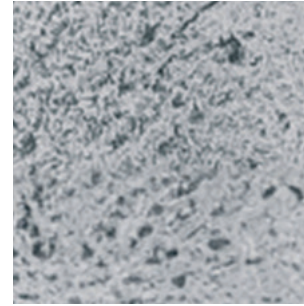

**VT**

VEROUDERDE  
TINKLEUR

COULEUR  
ÉTAIN VIEILLI



**VZ**

VEROUDERD  
ZWART

NOIR  
VIEILLI



**RK**

ROOD  
KOPER

CUIVRE  
ROUGE



**DB2371VZ**



**DB2371RK**



DB2370RK





DB2370VT



DB2370VZ



DB2370RK

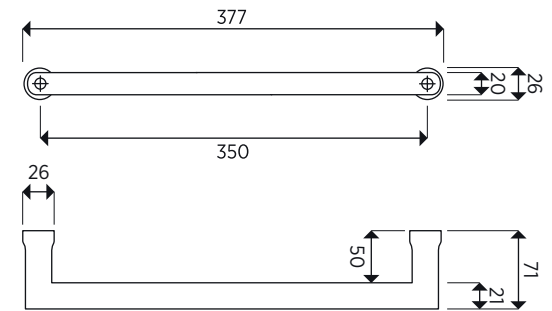



DB2371VT



DB2371VZ



DB2371RK

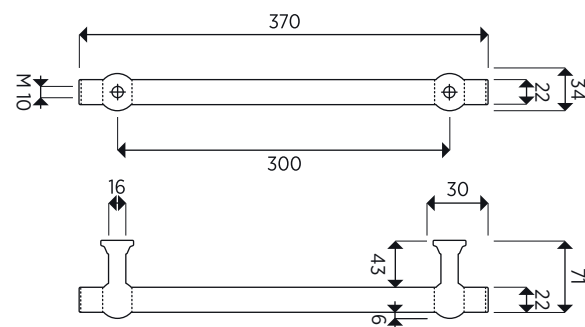



**DB3342RK**



**DB3342VT**



**DB3342VZ**



**DB3342RK**

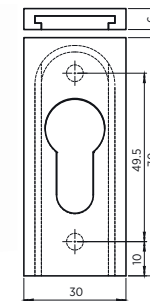



DB2350SN

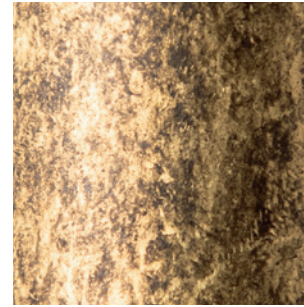

**VB**

VEROUDERDE  
BRONSKLEUR

BRONZE  
VIEILLI



**SN**

TIN

ETAIN

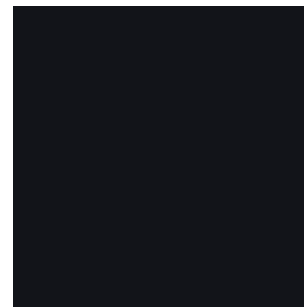

**ZW**

ZWART

NOIR



DB2350VB



DB2350SN



DB2350ZW

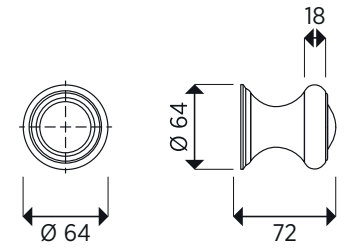

DB2351VB



DB2351SN



DB2351ZW

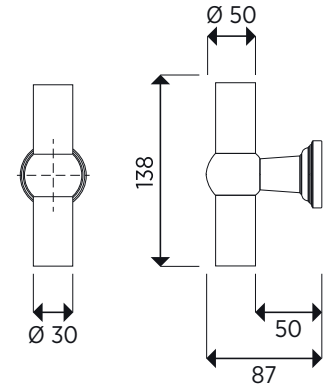

DB2352VB



DB2352SN



DB2352ZW

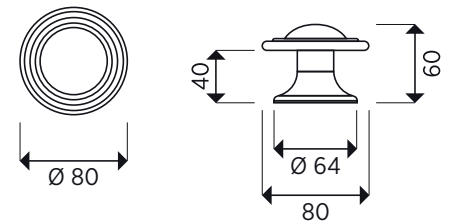



**DB2353SN**

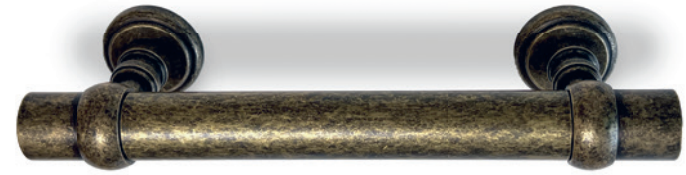

**DB2353VB**

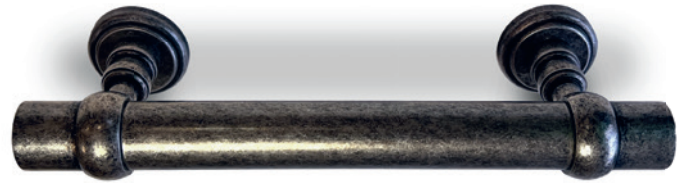

**DB2353SN**



**DB2353ZW**

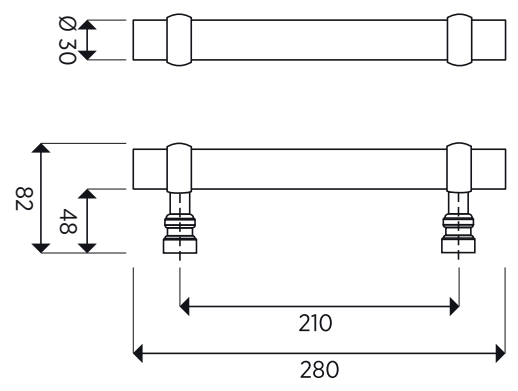



DB2354VB



DB2354SN



DB2354ZW

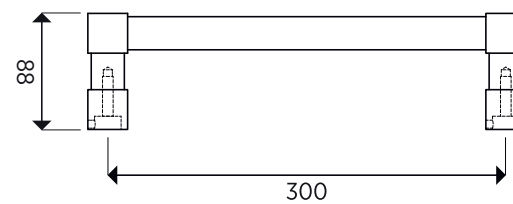



**DB2361VB**



**DB2361SN**



**DB2361ZW**

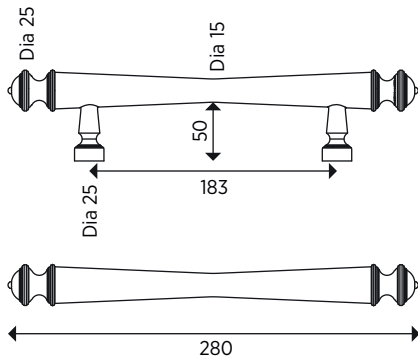





DB1359VB



DB1360VB



DB3356VB



DB1359SN



DB1360SN



DB3356SN



DB1359ZW



DB1360ZW



DB3356ZW

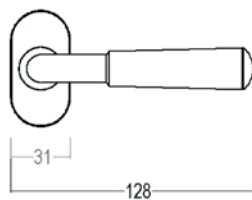
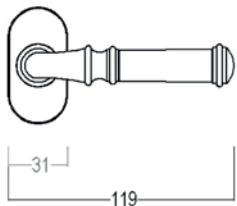

Al onze deurkrukken  
zijn zowel links als rechts  
te gebruiken.

Toutes nos poignées  
peuvent être utilisées aussi bien  
à gauche qu' à droite

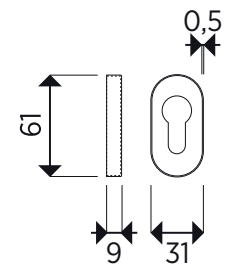



DB1363VB



DB3362VB

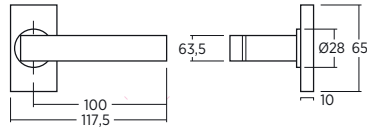

DB1363SN



DB3362SN

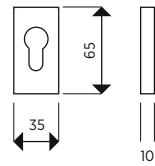

DB1363ZW



DB3362ZW

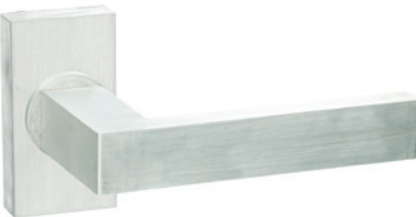

DB1363PL



DB3362PL





Al onze deurkrukken zijn zowel links als rechts te gebruiken.

Toutes nos poignées peuvent être utilisées aussi bien à gauche qu' à droite

 **NEW**

De deurkruk DB1363PL en het cylinderplaatje DB3362PL zijn voortaan ook in poederlak mogelijk.

La poignée DB1363PL et le cache-cylindre DB3362PL sont désormais également possible en thermolaquage.

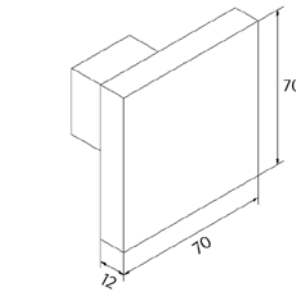

DB2211

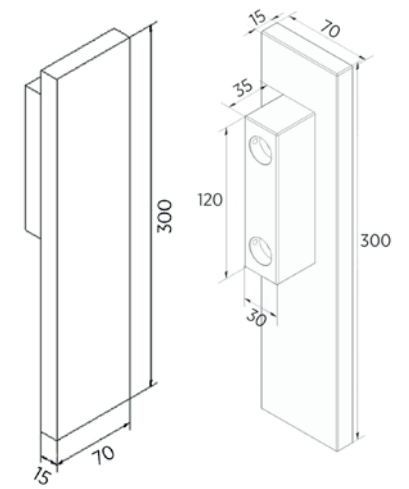

DB2212





**BUITEN | EXTÉRIEUR**



**BINNEN | INTÉRIEUR**

EXTERIEUR



**DB4355VB**



**DB4355SN**



**DB4355ZW**



**DB4355IN**

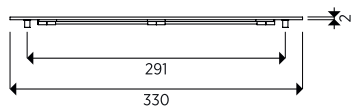
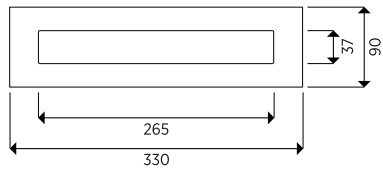

INTERIEUR



**DB4357**

IN ZW

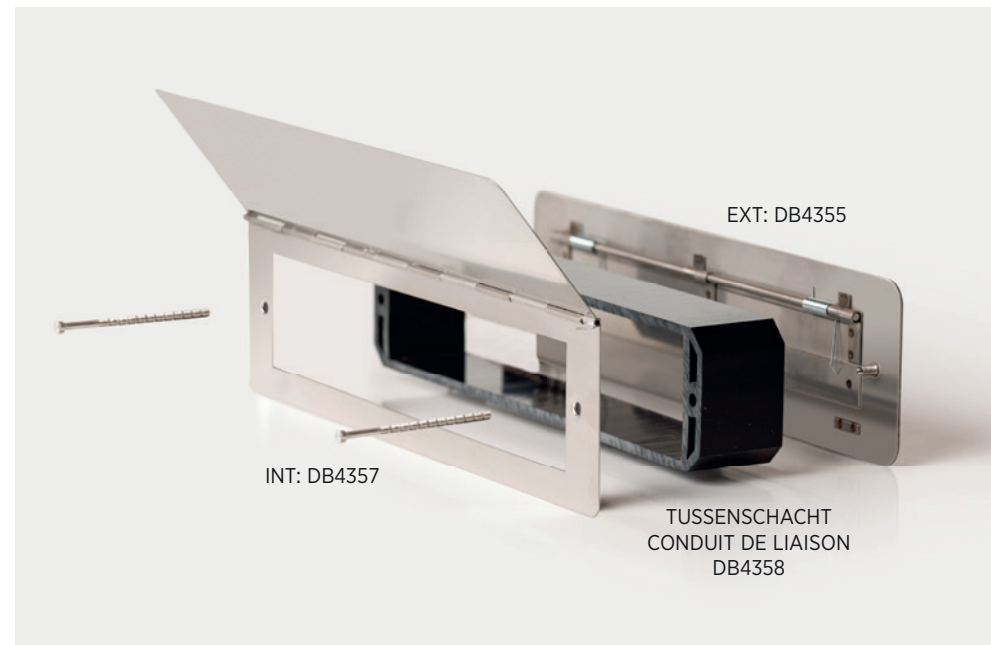
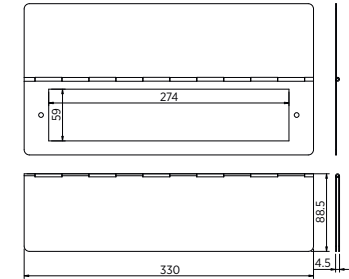



**OPLIGGEND | EN APPLIQUE**



**GELIJKLIGGEND | À FLEUR DU PANNEAU**



Bij gelijkliggende montage is de buitenklep steeds in hetzelfde kleur als het paneel. De klep aan de binnenzijde is nooit gelijkliggend.

Dans le cas d'un montage à fleur du panneau, le clapet extérieur est toujours de la même couleur que le panneau. Le clapet intérieur n'est jamais à fleur.

**BIJ GELIJKLIGGEND / À FLEUR :**  
Enkel mogelijk in Magnetude®  
Uniquement possible en Magnetude®

**BIJ OPLIGGEND / EN APPLIQUE :**  
Mogelijk in inbouw én in Magnetude®  
Possible pour pose en feuillure et en Magnetude®



**BINNENKLEP | CLAPET INTÉRIEUR**



DB2295IN



**IN**

INOX

(AISI 316)

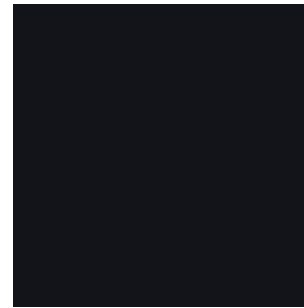

**ZW**

ZWART

NOIR

(AXALTA SD30C - 49005 - 20)



**PL**

POEDERLAK

RAL POWDRE

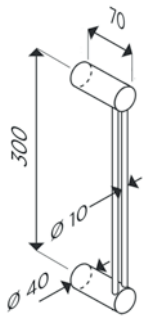

**DB2120**

IN ZW PL

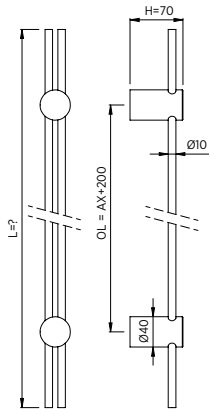

**DB2123**

AX=300

**DB2124**

AX=500

IN ZW PL



**DB2124IN**



**DB2128IN**

Realisatie bovenlicht | Imposte : Frager Facade

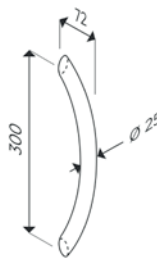

**DB2125**

IN ZW PL

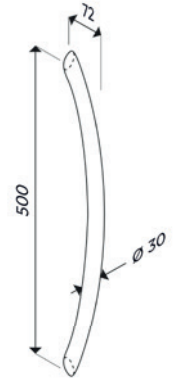
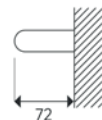

**DB2126**

IN ZW PL

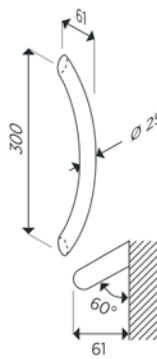
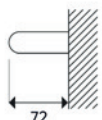

**DB2127**

IN ZW PL

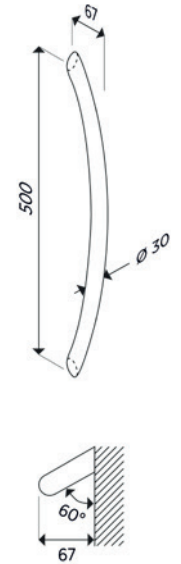

**DB2128**

IN ZW PL





**DB2133IN**

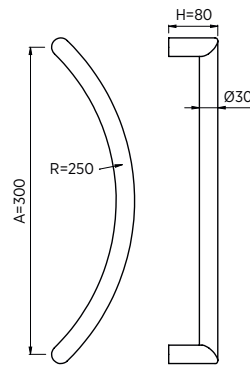

**DB2131**

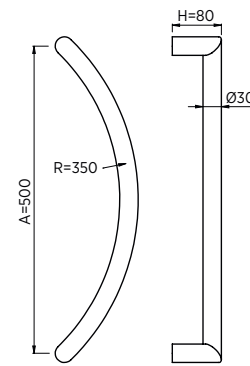

**DB2132**

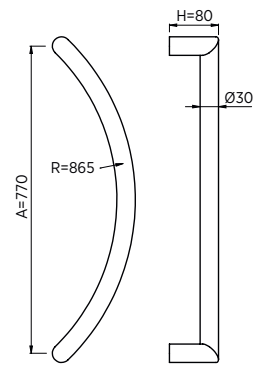
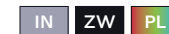

**DB2133**



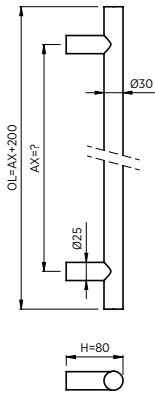
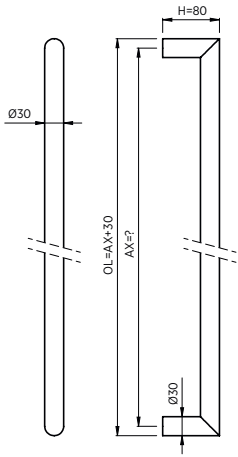

**DB2134**  
AX=300  
**DB2135**  
AX=650  
**DB2136**  
AX=1000

**DB2140**  
AX=300  
**DB2141**  
AX=500  
**DB2142**  
AX=1000



**DB2140ZW**

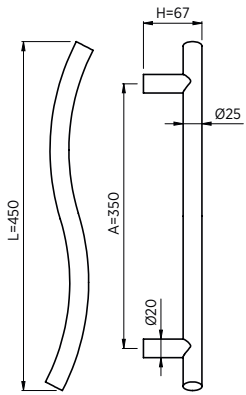

**DB2152**

IN ZW PL

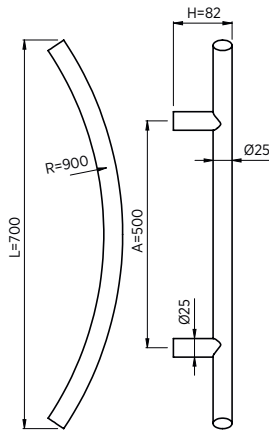

**DB2153**

IN ZW PL

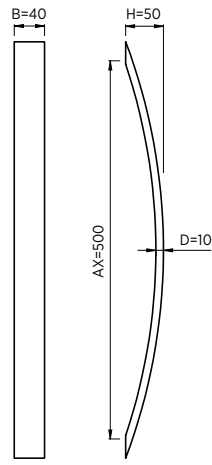

**DB2154**

IN ZW PL



**DB2153IN**

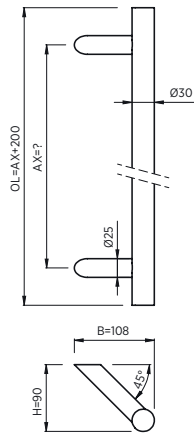

**DB2224**

AX=300

**DB2225**

AX=500

**DB2226**

AX=700

**DB2227**

AX=1000

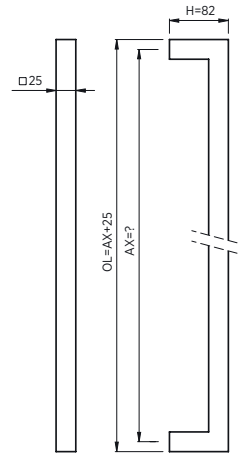

**DB2250**

AX=300

**DB2251**

AX=500

**DB2263**

AX=700

**DB2252**

AX=1000

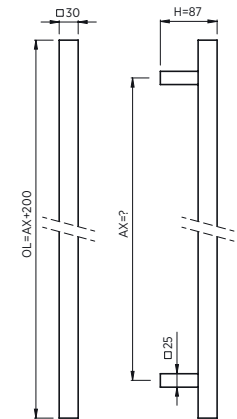

**DB2253**

AX=300

**DB2254**

AX=500

**DB2264**

AX=700

**DB2255**

AX=1000



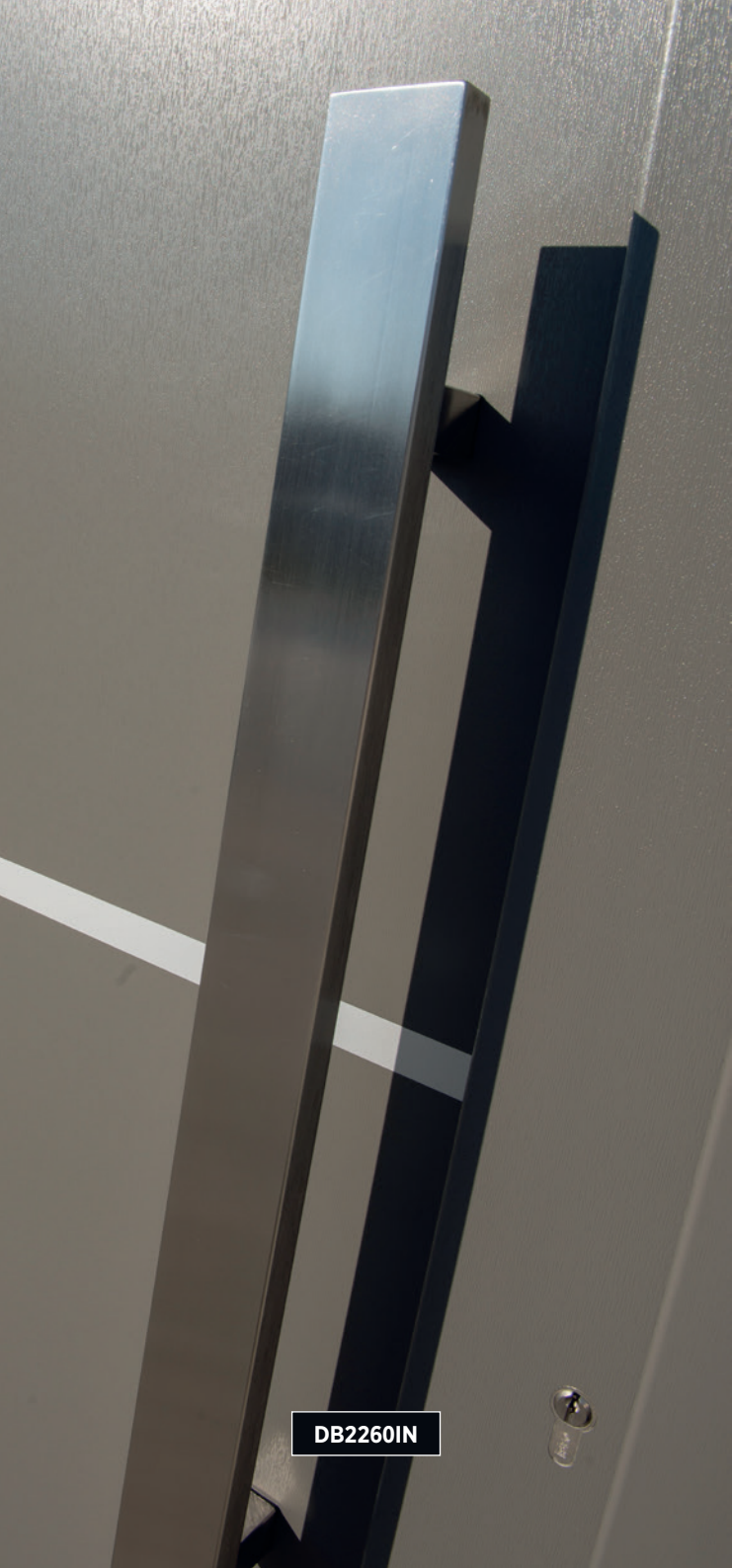

DB2260IN

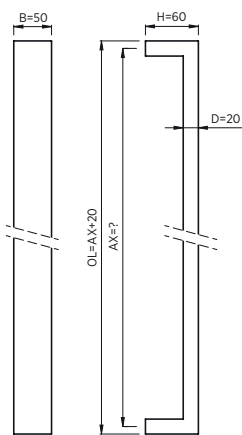

**DB2256**  
AX=300  
**DB2262**  
AX=500  
**DB2265**  
AX=700  
**DB2257**  
AX=1000

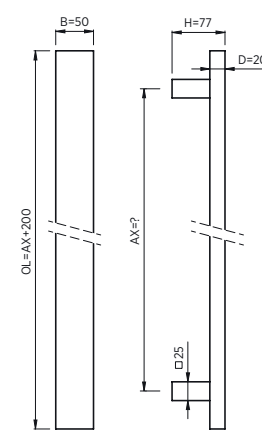
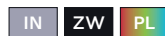

**DB2259**  
AX=300  
**DB2260**  
AX=500  
**DB2266**  
AX=700  
**DB2261**  
AX=1000



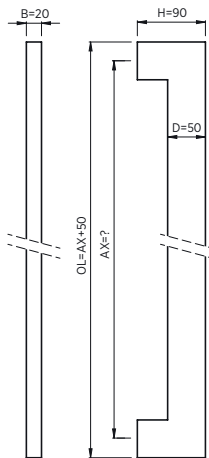

**DB2292**

AX=500

**DB2293**

AX=1000

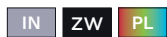

**DB2292PL**

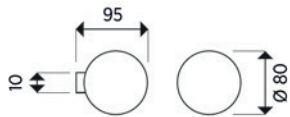

**DB2143**

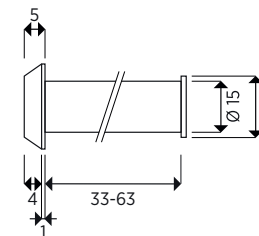
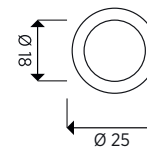

**DB6029**

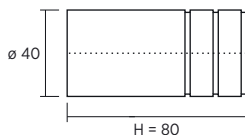

**DB2294**

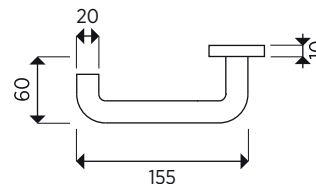

**DB1215**

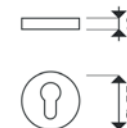

**DB3202**

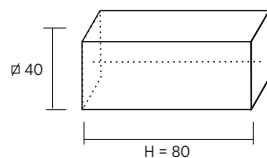

**DB2295**

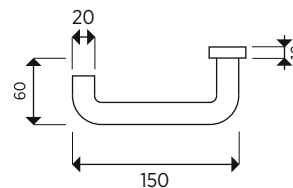

**DB1216**



**DB3201**



# ENKEL GESCHIKT VOOR TRADITIONELE MONTAGE

## CONVIENT SEULEMENT AU MONTAGE TRADITIONNEL

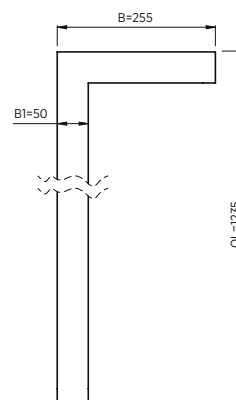
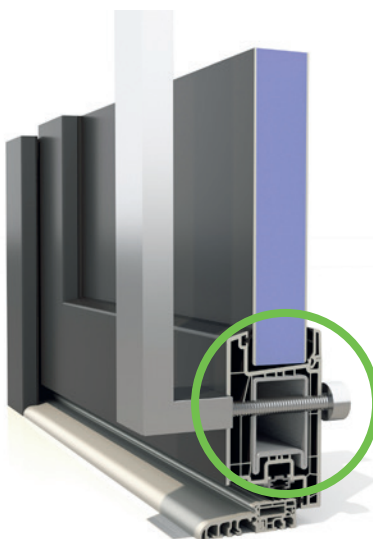

**DB2790**

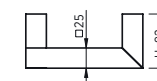
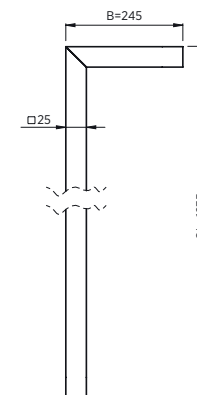

**DB2791**

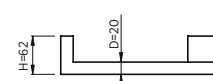
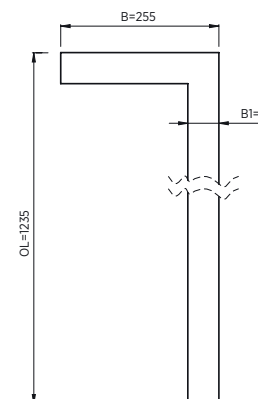

**DB2290**

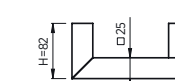
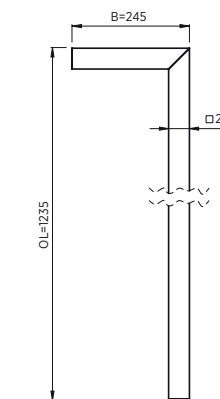

**DB2291**



**DB2791ZW**



# GESCHIKT VOOR MAGNETUDE® MONTAGE

## CONVIENT AU MONTAGE MAGNETUDE®

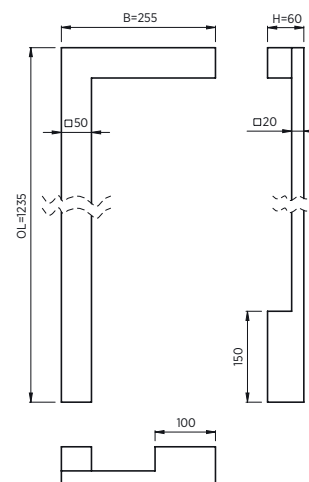

**DB2721**

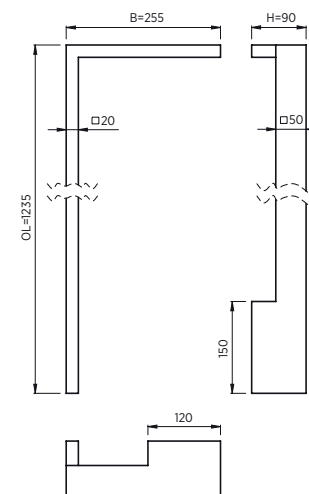

**DB2722**

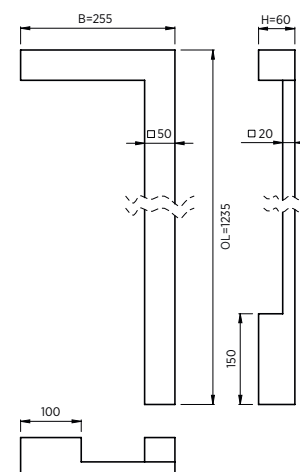

**DB2221**

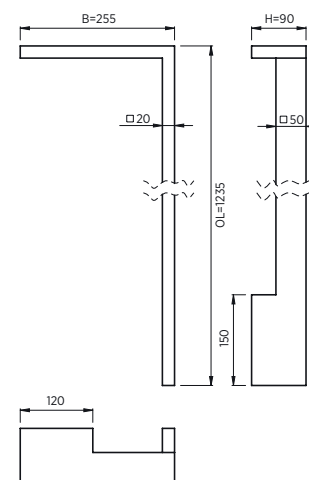

**DB2222**



7

**DB2791ZW**



**PL**

POEDERLAK

RAL POUUDRE

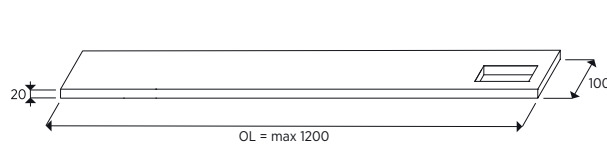

**DB2811PL**  

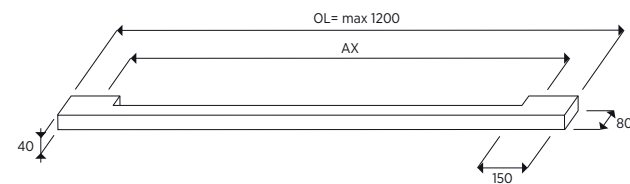

**DB2813PL**  

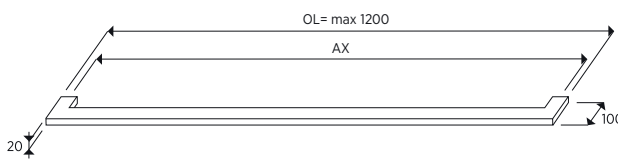

**DB2816PL**  

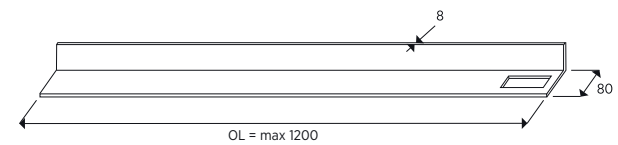

**DB2817PL**  

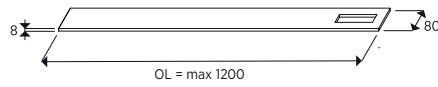

**DB2818PL**  

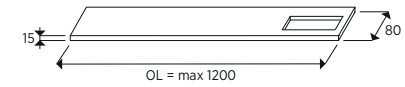

**DB2821PL**  

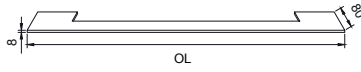

**DB2860PL**  

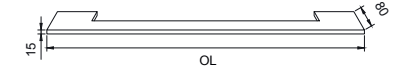

**DB2861PL**  

**DB2818ZW**



DB2911PL

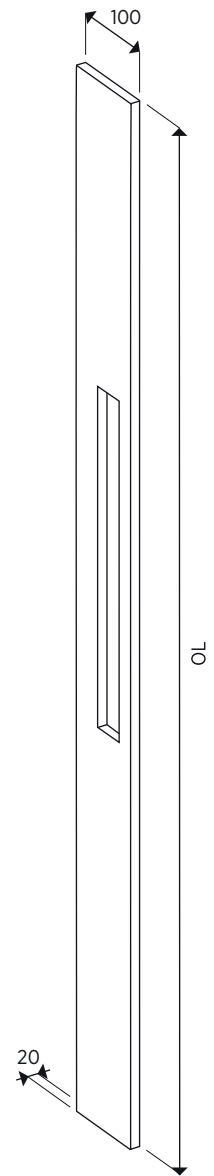

DB2911PL

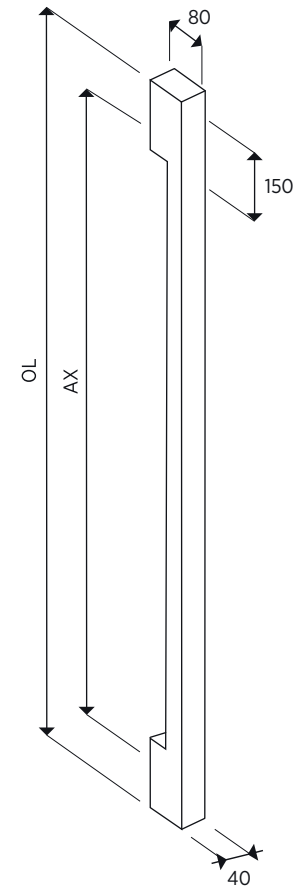

DB2913PL

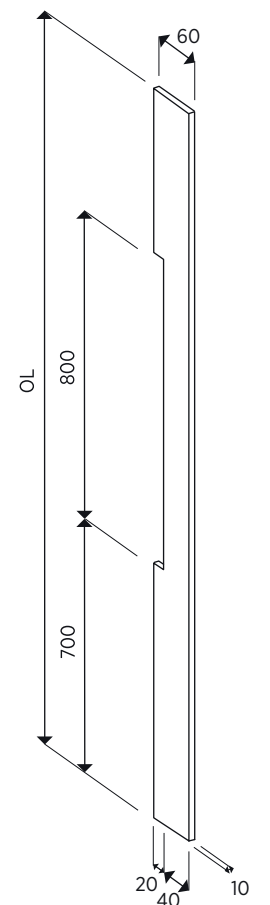

DB2914PL





DB2717PL

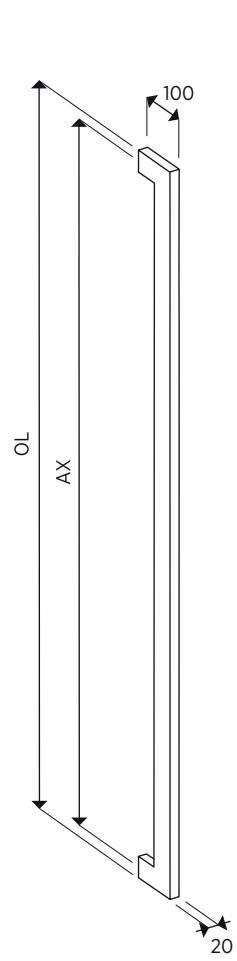

DB2916PL

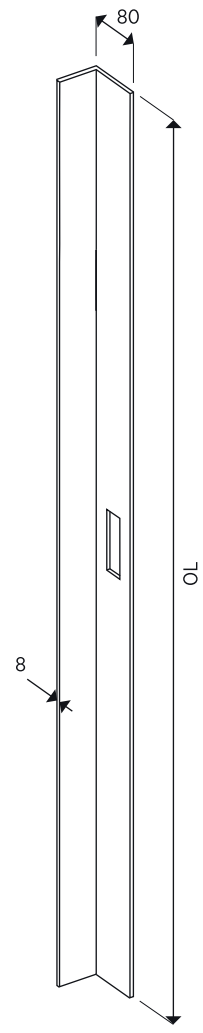

DB2717PL

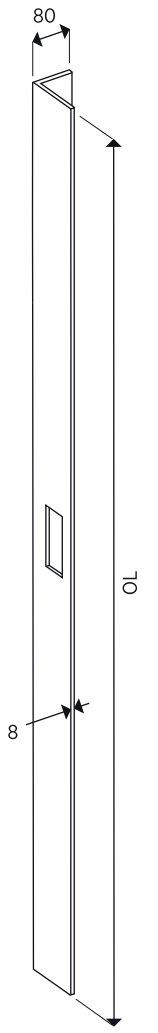

DB2917PL





OL = max. 2500

**DB2950PL**

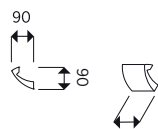

OL = max. 1200

**DB2850PL**



OL = max. 2500

**DB2951PL**

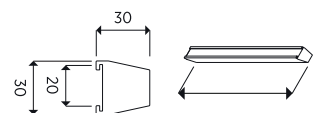

OL = max. 1200

**DB2851PL**

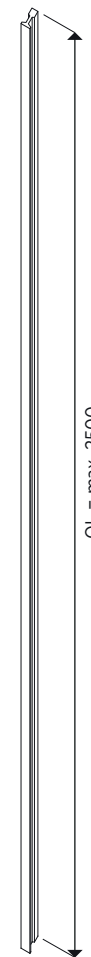

OL = max. 2500

**DB2952PL**

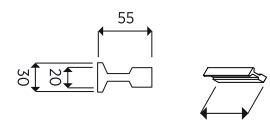

OL = max. 1200

**DB2852PL**

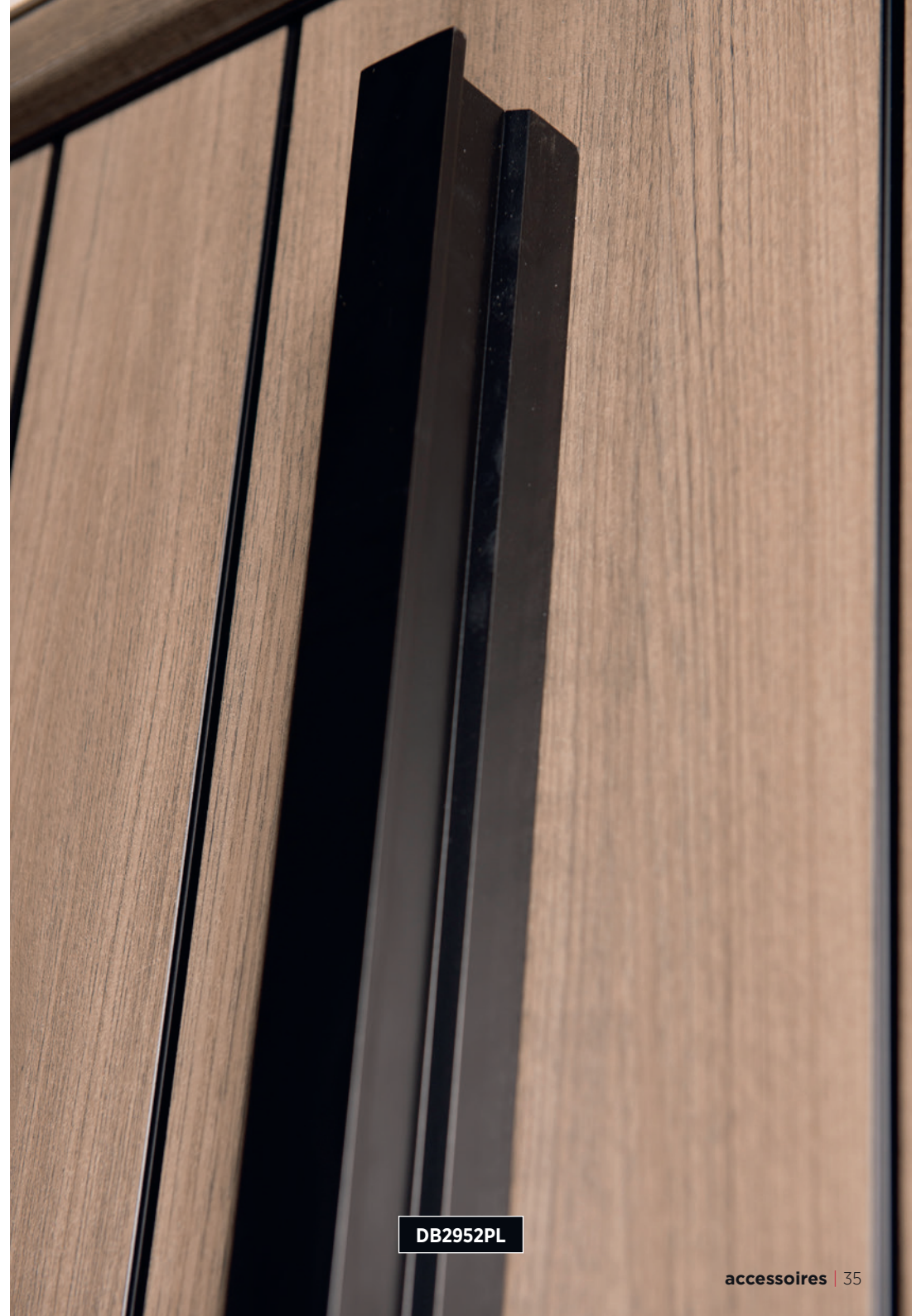

**DB2952PL**

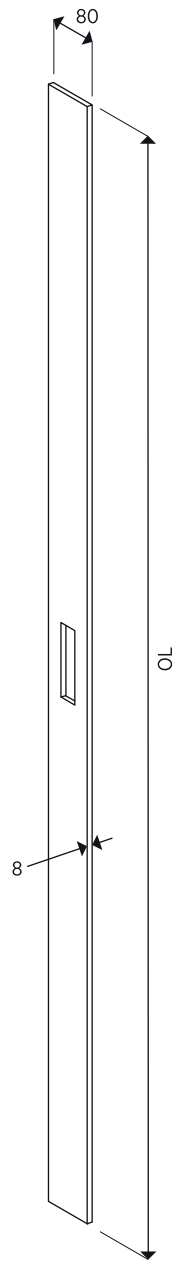

**DB2918PL**

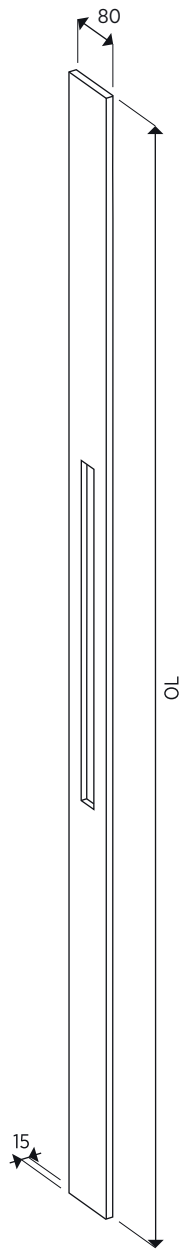

**DB2921PL**



**DB2921PL**



**DB2960PL**

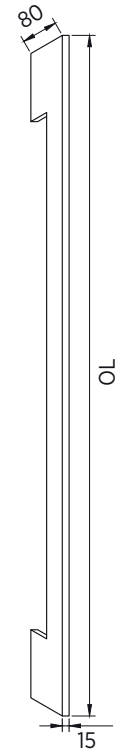

**DB2961PL**





**DB2022PL**

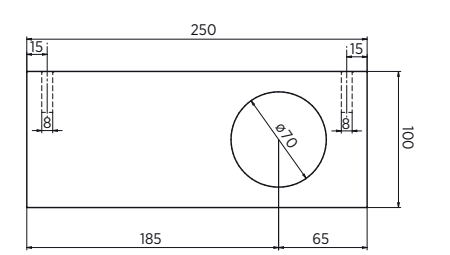
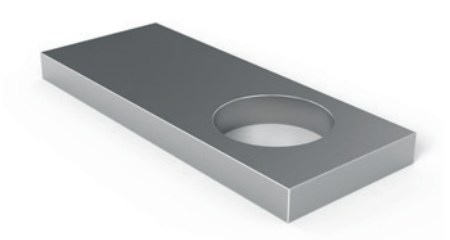

**DB2022PL**

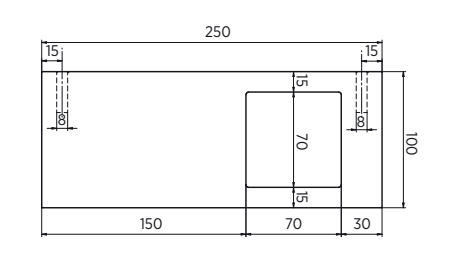
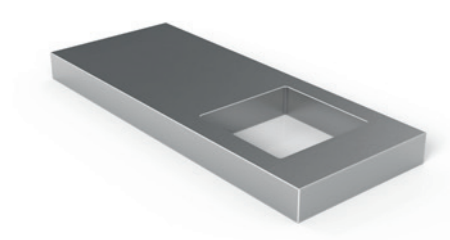

**DB2023PL**

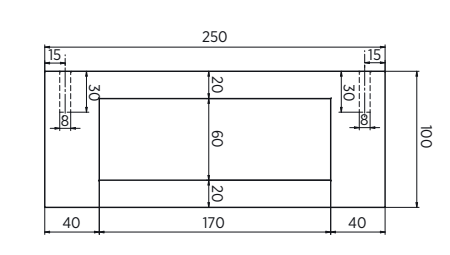
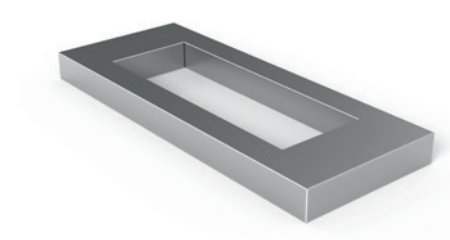

**DB2024PL**

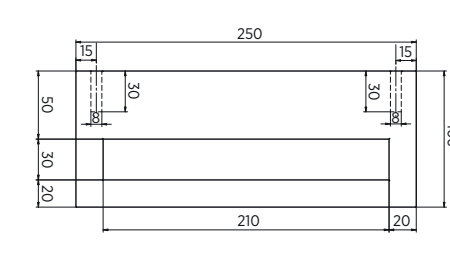

**DB2025PL**



# forms

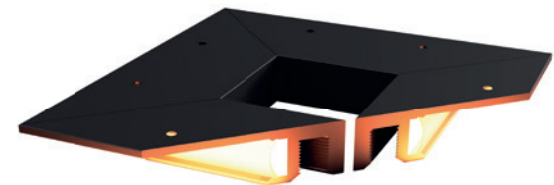
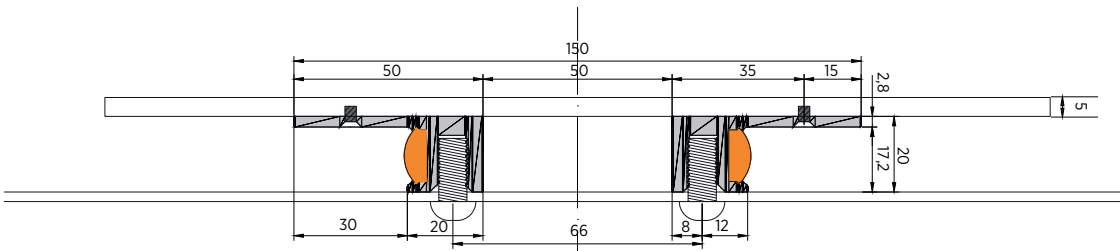
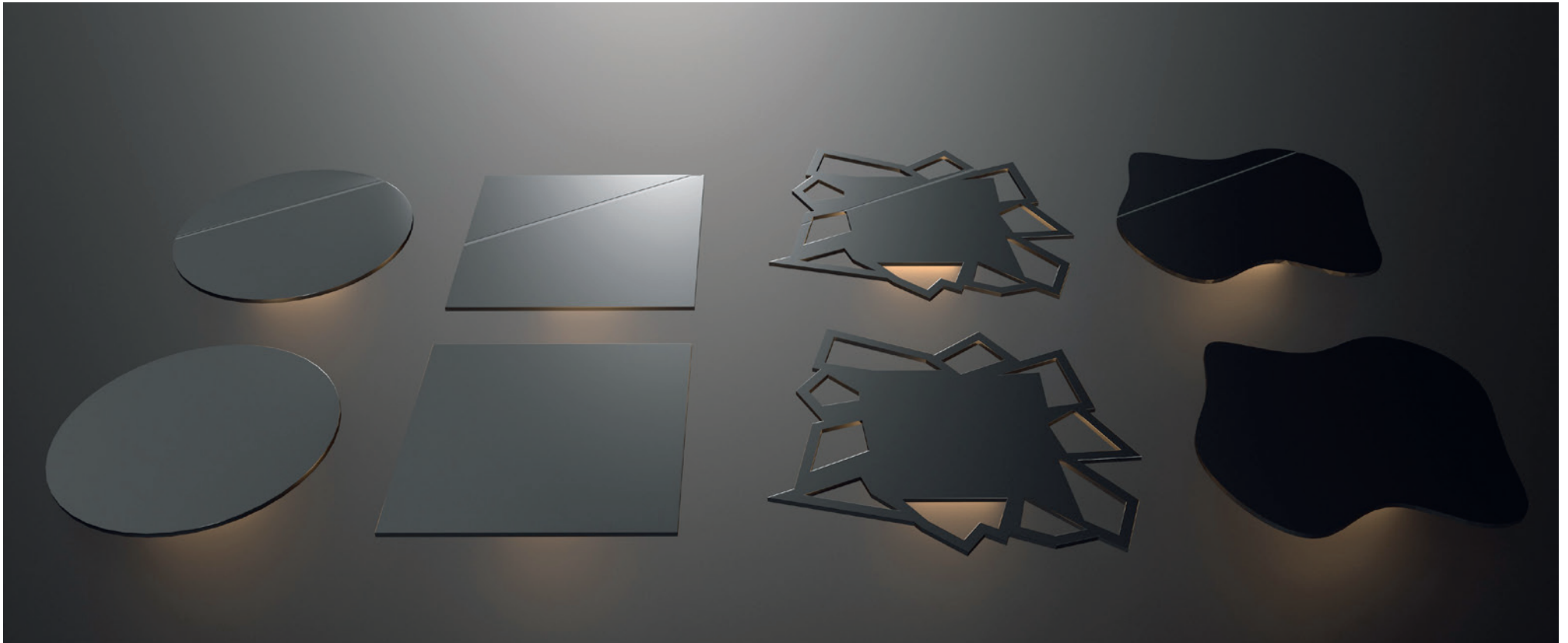





**DB2001PL**



**DB2002PL**



**DB2003PL**



**DB2004PL**



**DB2005PL**



**DB2006PL**



**DB2007PL**

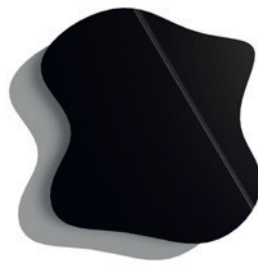

**DB2008PL**

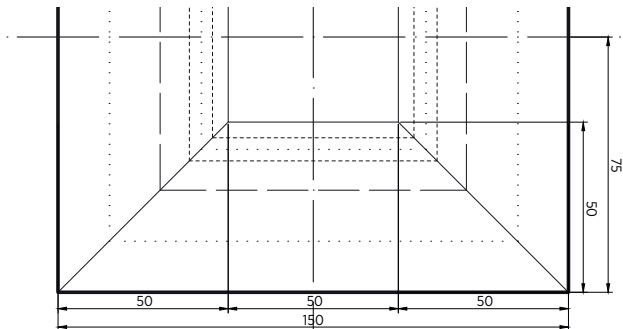

**DB2006PL**

# plates

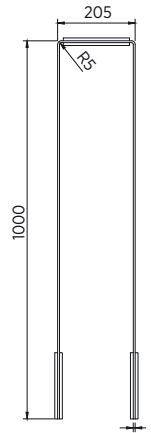
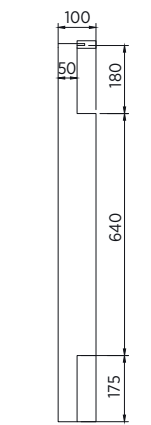
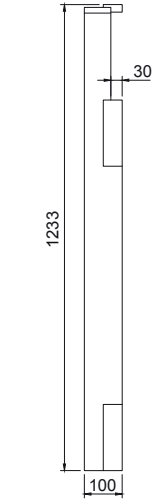
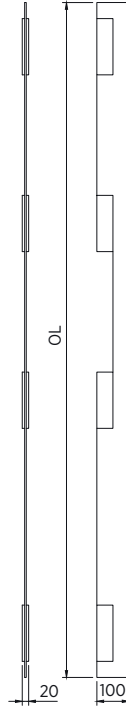
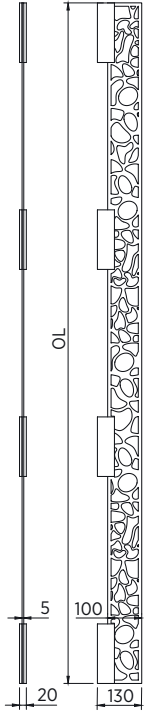

DB2009PL



DB2010PL



DB2013PL

DB2014PL

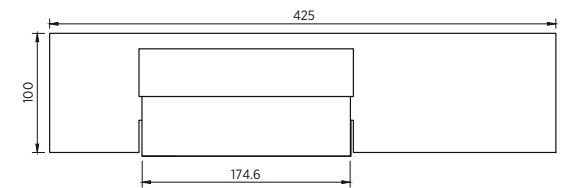
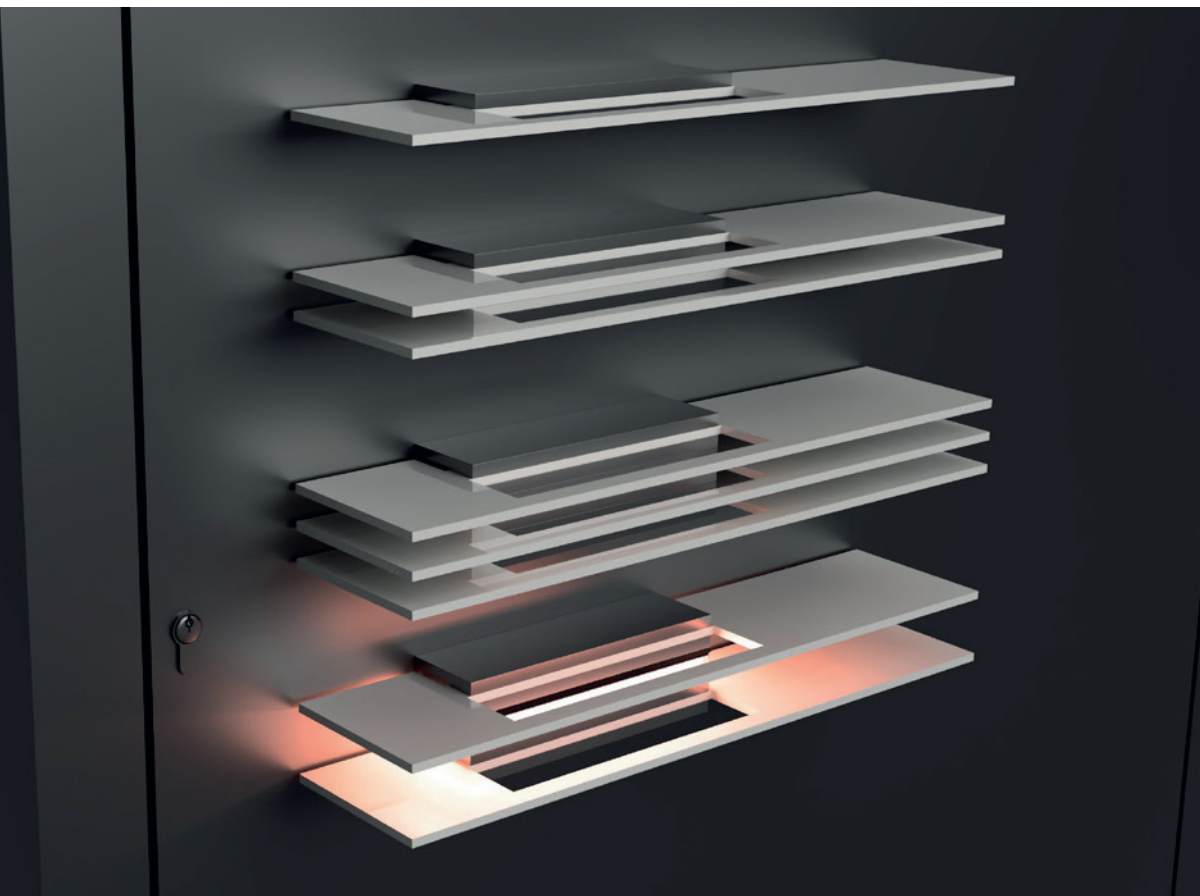

**DB2011PL**



**DB2015PL**



**DB2012PL**



**DB2016PL**

## MONTAGE-INSTRUCTIES | INSTRUCTIONS DE MONTAGE

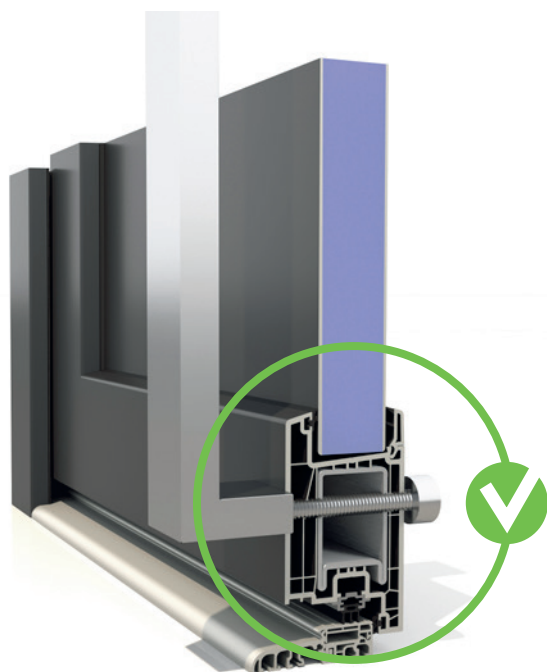

### Doorgaande montage op een traditioneel inbouwpaneel

Bevestigingsbouten zijn standaard steeds in dezelfde afwerking als de gevraagde deurgreep.

### Assemblage au travers d'un panneau de remplissage traditionnel

En standard, les écrous de fixation sont toujours dans la même finition que la poignée de porte demandée.



### Doorgaande montage op Magnetude® vleugeloverdekkend paneel

Doorgaande bevestiging op een Magnetudepaneel belemmert de werking van het systeem dat kromtrekking tegengaat. Deze manier van bevestigen is dan ook absoluut niet toegestaan en doet alle garantie over kromtrekking vervallen.

### Assemblage au travers d'un panneau cache-ouvrant Magnetude®

Un montage au travers sur un panneau Magnetude® gêne le fonctionnement du système anti-dilatation. Cette méthode de fixation n'est pas autorisée et annule toute garantie concernant une éventuelle dilatation du panneau.



### Onzichtbare bevestiging op een Magnetude® vleugeloverdekkend paneel

Boorgaten worden door ons voorzien in de voorplaat indien de positie bij bestelling doorgegeven wordt, dit om een vlotte en nauwkeurige montage te garanderen.

### Fixation invisible sur un panneau cache-ouvrant Magnetude®

Les trous de fixation peuvent être prévus par nous dans la plaque extérieure si la position est communiquée à la commande, cela permet d'assurer un assemblage fluide et précis.

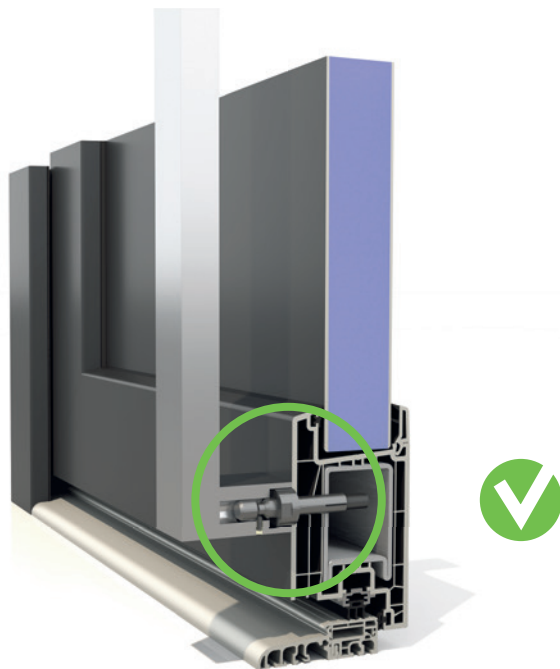

#### **Blinde montage op een traditioneel vulpaneel**

Dit is enkel mogelijk bij montage op de deurvleugel, niet op het vulpaneel.

#### **Montage aveugle sur un panneau de remplissage traditionnel**

Ceci n'est possible que si le montage est effectué sur l'ouvrant de la porte, et non sur le panneau de remplissage.



#### **Paarsgewijze montage op een traditioneel vulpaneel**

Dit kan zowel op de deurkader als op het vulpaneel zelf gemonteerd worden.

#### **Montage en paire sur un panneau de remplissage traditionnel**

Il peut être monté sur le cadre de la porte ou sur le panneau de remplissage même.



Om te weten welke artikelen er mogelijk zijn met blinde of paarsgewijze bevestiging (\*), verwijzen we graag naar de index op pagina 2.

Pour savoir quels articles sont adaptés pour montage aveugle ou en paire (\*), nous nous référons à la page 2 où vous trouverez ces infos dans le sommaire.

## ONDERHOUDSVOORWAARDEN EN GARANTIES | ENTRETIEN ET GARANTIES

**INOX:** deurgrepen in RVS (AISI 316) genieten van een 10-jarige fabrieksgarantie mits het regelmatig reinigen met lauw water en een zachte doek. Het oppervlak moet nadien steeds drooggewreven worden om oppervlakkige roestvorming en droogvlekken te voorkomen. Het eventueel beschermen met inoxpoets of het aanbrengen van polijstmiddelen om extra bescherming te bieden kan enkel mits de aanwijzingen daarvoor opgevolgd worden.

**VZ:** deurgrepen in verouderd zwart zullen door gebruik op natuurlijke wijze verweren. Daarom kan er geen garantie gegeven worden op uiterlijke veranderingen. Het is aangeraden om deze naast het onderhoud op regelmatige basis te behandelen met bijenwas om dit proces te vertragen.

**VT-VB-SN:** deurgrepen in messing regelmatig reinigen met lauw water en een zachte doek. Na verloop van tijd gaan deze patineren en ontstaat er een mattere en warmere kleur. Deze grepen vallen hierdoor niet onder garantie.

**RK:** deurgrepen in koper zal door de chemische reactie met zuurstof donkerder worden, waar er meer wrijving is door bv. menselijk contact zal het daar terug lichter worden. Deze artikelen vallen hierdoor niet onder de garantie. Ze kunnen best beschermd worden door regelmatig gebruik van koperpoets mits de aanwijzingen daarvoor opgevolgd worden.

**ZWART-PL:** deurgrepen in poederlak genieten van de 10-jarige fabrieksgarantie mits regelmatig te reinigen met lauw water en een zachte doek. Andere specifieke onderhoudsproducten worden gebruikt op eigen risico. Het is aan te raden om steeds grondig na te spoelen met proper water en droog te wrijven met een zachte doek.

**Gebruik nooit staalwol, of sterk schurende schoonmaakmaterialen. Gebruik enkel niet schurend zeepwater of organische/neutrale oplosmiddelen om vingerafdrukken, olie of vet te verwijderen. Gebruik in geen enkel geval chloor of ander agressieve reinigingsmiddelen!**

**INOX :** La garantie décennale s'applique sur ce genre d'articles à condition que vous nettoyez régulièrement les poignées de porte en acier inoxydable (AISI 316) avec de l'eau tiède et un chiffon doux. Essuyez toujours la surface après le nettoyage pour éviter la rouille superficielle et les taches sèches. Si nécessaire, protégez avec un nettoyeur spécial inox ou appliquez des agents de polissage pour assurer une protection supplémentaire, uniquement si les instructions sont respectées.

**VZ :** Les poignées de porte en noir vieilli s'altèrent naturellement à l'usage. Pour cette raison, ces articles ne bénéficient pas de garantie. Il est recommandé de les traiter régulièrement avec de la cire d'abeille, en plus de l'entretien régulier, afin de ralentir ce processus.

**VT-VB-SN :** Les poignées de porte en laiton doivent être nettoyées régulièrement avec de l'eau tiède et un chiffon doux. Avec le temps, elles se patineront et prendront une couleur mate et plus chaude. Ces articles ne sont pas couverts par la garantie.

**RK :** Les poignées de porte en cuivre s'assombrissent en raison de la réaction chimique avec l'oxygène, et s'éclaircissent là où il y a plus de friction, par exemple au contact de l'homme. Ces articles ne peuvent donc pas être garantis. Ces objets peuvent être protégés par l'utilisation régulière d'un vernis pour cuivre, à condition de respecter les instructions.

**ZW-PL :** les poignées de porte revêtues de poudre doivent être nettoyées régulièrement avec de l'eau tiède et un chiffon doux. Sous cette condition, ils bénéficient d'une garantie décennale. L'utilisation d'autres produits d'entretien spécifiques se fait à vos risques et périls. Rincez toujours abondamment à l'eau claire et essuyez avec un chiffon doux.

**N'utilisez jamais de laine d'acier ou de produits de nettoyage très abrasifs sur les poignées de porte. N'utilisez que de l'eau savonneuse non abrasive ou des solvants organiques/neutres pour nettoyer les poignées de porte.**

## ONS COMPLETE GAMMA

Niet gevonden wat u zocht?  
Vraag naar onze andere brochures.

Wedden dat we uw favoriete deur hebben?

## ONS COMPLETE GAMMA

Niet gevonden wat u zocht?  
Vraag naar onze andere brochures.

Wedden dat we uw favoriete deur hebben?

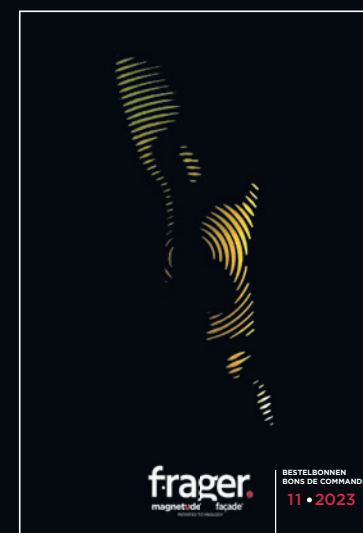

frager.  
CREATORS OF DOORS



# frager.

magnetude<sup>®</sup> façade<sup>®</sup>  
PATENTED TECHNOLOGY

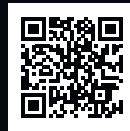

Frager Facade



[www.frager.be](http://www.frager.be)

**HARINCK nv/sa**  
Heirweg 95, zone 2  
B-8710 Wielsbeke  
[info@frager.be](mailto:info@frager.be)

**BELGIË/BELGIQUE**  
T +32 (0)56 67 40 50  
[facade@frager.be](mailto:facade@frager.be)

[www.frager.be](http://www.frager.be)