

[www.somfy.be](http://www.somfy.be)

## Handboek installateur

HOME  
MOTION BY

**somfy.**

## INHOUDSTAFEL

<b>A</b>	<b>Afregelen motoren</b>	<b>Zie betreffende motor</b>	
	<b>Altus 50 RTS - Altus 60 RTS</b>	<b>Afstellen Altus RTS Motor</b>	<b>2</b>
		<b>Eindpunten aanpassen</b>	<b>15</b>
		<b>Eindpunten afstellen</b>	<b>3</b>
		<b>Gedeeltelijk wissen geheugen</b>	<b>19</b>
		<b>Programmatie zenders</b>	<b>12</b>
		<b>Tussenpositie</b>	<b>16</b>
		<b>Volledig wissen van het geheugen</b>	<b>20</b>
		<b>Zenders wissen</b>	<b>13</b>
<b>C</b>	<b>Centralis IB</b>	<b>Aansluiting</b>	<b>97</b>
	<b>Centralis Indoor RTS</b>	<b>Aansluiting</b>	<b>22</b>
		<b>Plaats programmatietoets</b>	<b>21</b>
		<b>Programmatie zender</b>	<b>12</b>
		<b>Tussenpositie</b>	<b>95</b>
		<b>Volledig wissen van het geheugen</b>	<b>20</b>
	<b>Centralis Uno IB</b>	<b>Aansluiting</b>	<b>97</b>
	<b>Centralis Uno RTS</b>	<b>Aansluiting</b>	<b>23</b>
		<b>Plaats programmatietoets</b>	<b>21</b>
		<b>Programmatie zender</b>	<b>12</b>
		<b>Tussenpositie</b>	<b>95</b>
		<b>Volledig wissen van het geheugen</b>	<b>20</b>
	<b>Chronis Easy (Uno en RTS)</b>	<b>Aansluiting</b>	<b>61</b>
		<b>Display en toetsen</b>	<b>66</b>
		<b>Programmatie</b>	<b>67</b>
		<b>Programmatie OP en NEER tijden</b>	<b>68</b>
	<b>Chronis Smart (Uno en RTS)</b>	<b>Aansluiting</b>	<b>61</b>
		<b>Display en toetsen</b>	<b>69</b>
		<b>Gebruik met binnen en buiten jaloezieën</b>	<b>75</b>
		<b>Programmatie</b>	<b>70</b>
		<b>Programmatie Cosmic functie</b>	<b>72</b>
		<b>Programmatie OP en NEER tijden</b>	<b>74</b>
		<b>Programmatie SEC functie</b>	<b>74</b>
	<b>Chronis Comfort (Uno, RTS en IB)</b>	<b>Aansluiting</b>	<b>61</b>
		<b>Display en toetsen</b>	<b>76</b>
		<b>Gebruik met binnen en buiten jaloezieën</b>	<b>87</b>
		<b>Instellen speling en spertijd functie</b>	<b>79</b>
		<b>Inschakelen Lichtsensor</b>	<b>84</b>

## INHOUDSTAFEL

	Programmatie	77
	Programmatie OP en NEER tijden	86
	Programmatie Cosmic functie	79
	Programmatie SEC functie	86
	Tussenpositie	88
	Instellen schemerfunctie	85
Codeklavier RTS	Extra codes	109
	Één code wissen	110
	Hoofdcodes wissen	108
	Programmeren op een ontvanger	107
<b>E</b>		
Eolis Box	Aansluiting	62
Eolis Wirefree 3D	Instellen van de drempelwaarde	27
	Programmatie	27
	Plaatsen van de batterijen	26
<b>I</b>		
Inis Duo	Aansluiting	54
Inis Uno	Aansluiting	53
<b>K</b>		
Keygo	Keygo toevoegen	14
<b>L</b>		
LS 40	Aansluiting	29
	Afregelen eindpunten	30
LT 50-LT 60	Aansluiting	32
	Afregelen eindpunten	33
LT 50 CSI - LT 60 CSI	Aansluiting	32
	Afregelen eindpunten	33
<b>O</b>		
Ontvanger	Plaats programmatietoets	21
	Programmeren van een zender	21
	Volledig wissen van de ontvanger	20
Orea 50 RTS - Orea 60 RTS	Afstellen van de motor	4
	Afregelen eindpunten	5
	Eindpunten aanpassen	15
	Gedeeltelijk wissen geheugen	19
	Back-impuls functie	17
	Programmatie zenders	12
	Tussenpositie	16
	Volledig wissen van het geheugen	20
	Zenders wissen	13

## INHOUDSTAFEL

<b>Orea WT</b>	Afregelen eindpunten	38
	Afstellen	36
	Volledig wissen van het geheugen	50
<b>Oximo 50 RTS</b>	Afstellen van de motor	6
	Afregelen eindpunten	7
	Eindpunten aanpassen	15
	Gedeeltelijk wissen geheugen	19
	Manuele afstelling	10
	Programmatie zenders	12
	Omkeren van de draairichting	18
	Tussenpositie	16
	Volledig wissen van het geheugen	20
Zenders wissen	13	
<b>Oximo WT</b>	Afstellen	41
	Afregelen eindpunten	45
	Automatisch afstellen	43
	Manuele afstelling	44
	Volledig wissen van het geheugen	50
<b>P Platine RTS</b>	Programmatie zender	105
	Volledig wissen van het geheugen	106
<b>Programmeertoets</b>	Plaatsing op de zender	11
	Plaatsing op de ontvanger	11
<b>R Relaiskasten</b>	Aansluiting in cascade	59
	Aansluiting Mini Relaiskast	60
	Aansluiting RK 1	55
	Aansluiting RK 2	56
	Aansluiting RK 2 met Chronis Uno	63
	Aansluiting RK 2 met Soliris Uno	65
	Aansluiting RK 3	57
	Parallelaansluiting	58
<b>RTS motoren</b>	Altus RTS, Orea RTS, Oximo RTS	1
	Solus RK	100
<b>Réglage des moteurs</b>	Voir moteur concerné	
<b>S Slim Receiver RTS</b>	Programmatie zender	105
	Volledig wissen van het geheugen	106

## INHOUDSTAFEL

	SLT 50 - SLT 60	Aansluiting	34
		Afregelen eindpunten	35
	Soliris IB	Aansluiting	99
	Soliris RTS	Aansluiting	25
	Soliris Uno	Aansluiting	64
		Aansluiting op relaiskast	65
		Tussenpositie	95
	Solus PA	Afregelen eindpunten	103
		Tussenpositie	95
	Solus RK	Afregelen eindpunten	103
		Geheugen volledig wissen	104
		Programmatie eerste zender	100
		Tussenpositie	95
	Sunis Wirefree RTS	Afstellen	25
<b>T</b>	Telis Compositio	Kanalen benoemen	91
		Programmatie van de zender	93
		Opstarten	90
		Rooster aanpassen	94
	Tussenpositie	Altus RTS, Orea RTS, Oximo RTS	16
		Solus RK, ontvangers en sturingen	95
<b>U</b>	Universal Receiver RTS	Aansluiting	24
		Geheugen volledig wissen	20
		Programmatie zender	21
		Plaats programmatietoets	21
		Tussenpositie	95
<b>W</b>	WT motoren	Herkennen van de WT motor	51
<b>Z</b>	Zender	Plaats programmeertoets	11
		Programmeren van een zender	12
		Wissen van een zender	13

# CONTROLE NEMEN VAN DE RTS MOTOR

(VANAF VERSIE 2004, ALTUS RTS, OREA RTS EN OXIMO RTS)

## 1 Motor onder spanning zetten

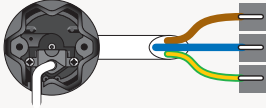

**Slechts 1 motor tegelijk onder spanning**

Korte beweging

**Als de motor kort heen en weer beweegt** zijn de eindpunten al ingesteld.  
Ga verder bij punt **2**

**Als de motor niet reageert**

1. De motor is nog niet afgesteld en geprogrammeerd:  
- voor Altus RTS, **p 2** - voor Orea RTS, **p 4** - voor Oximo RTS, **p 6**
2. De motor is al geprogrammeerd op de bijgeleverde zender, test door de NEER toets in te drukken.
3. De motor is geprogrammeerd op een zender die niet bij de motor geleverd is, ga naar **p 16**

## 2 Neem de controle over de motor



Korte beweging

## 3 Programmeer de zender op de motor

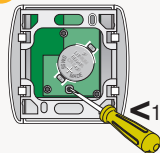

Achterkant Centralis

of



Achterkant Telis



Korte beweging → OK

## 4 Controleer de eindafstellingen

Indien niet OK -> **p 15**

## AFSTELLEN ALTUS RTS MOTOR

1 Neem de controle over de motor

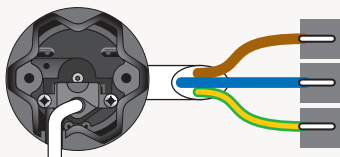

Slechts 1 motor tegelijk onder spanning

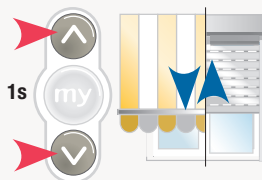

Korte beweging

2 Controleer de draairichting



OK → volgende pagina 4 of 5

3 Verander de draairichting - indien nodig



Korte beweging → 4 of 5

⚠ Afstelling gebeurt met een Telis of Centralis zender.

## AFSTELLEN ALTUS RTS MOTOR

**4 Afstellen onderste eindpunt**

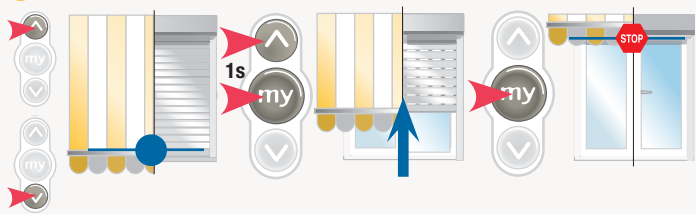

**5 Afstellen bovenste eindpunt**

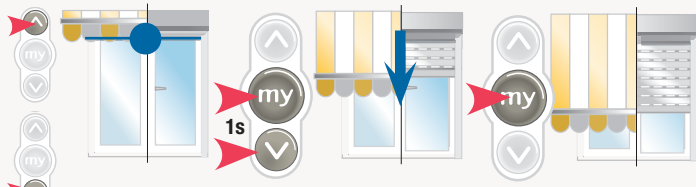

Bijregelen indien nodig

**6 Bevestig de eindafstellingen**

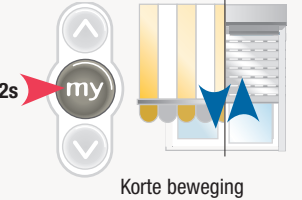

Korte beweging

**7 Programmeren van een zender**

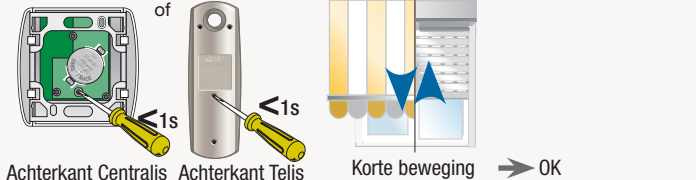

Achterkant Centralis of Achterkant Telis

Korte beweging → OK



## AFSTELLEN OREA RTS MOTOR

1 Neem de controle over de motor

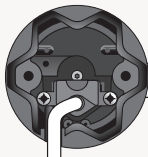

Slechts 1 motor tegelijk onder spanning

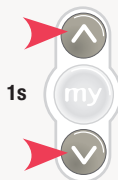

Korte beweging

2 Controleer de draairichting



OK → volgende pagina 4

3 Verander de draairichting - indien nodig



Korte beweging → 4

 Afstelling gebeurt met een Telis of Centralis zender.

## AFSTELLEN OREA RTS MOTOR

### 4 Open de tent

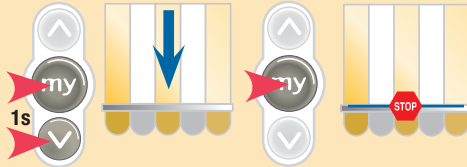

### 5 Afstellen onderste eindpunt

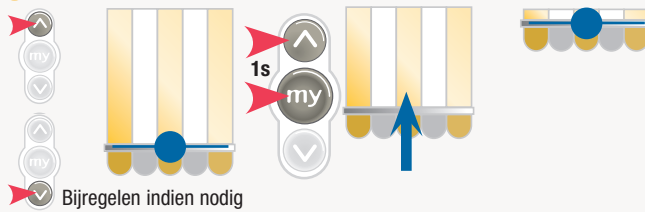

### 6 Bevestig de eindafstellingen

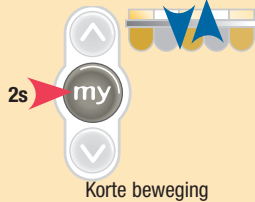

### 7 Programmeren van een zender

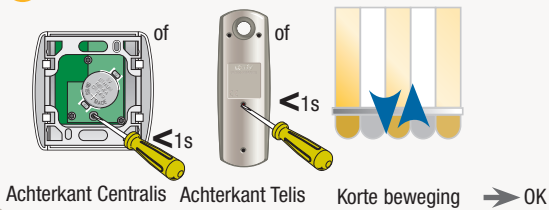

## AFSTELLEN OXIMO RTS MOTOR

### 1 Neem de controle over de motor

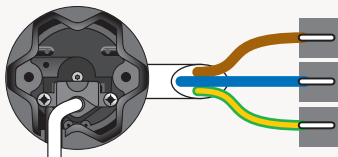

**Slechts 1 rolluik tegelijk onder spanning**



Korte beweging

### 2 Controleer de draairichting



OK → volgende pagina

### 3 Verander de draairichting - indien nodig



Korte beweging → volgende pagina

 Afstelling gebeurt met een Telis of Centralis zender.

## AFSTELLEN OXIMO RTS MOTOR

### Uitrusting van het rolluik

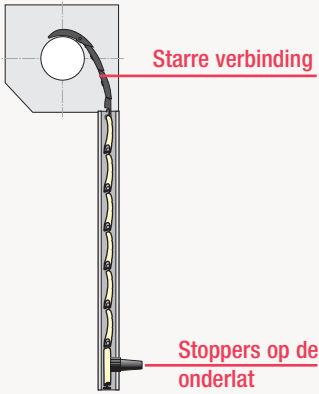

Automatische afstelling → 4

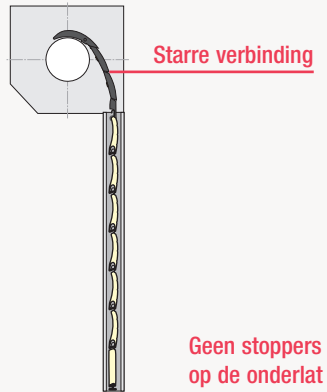

Enkel afstelling bovenste punt → 5

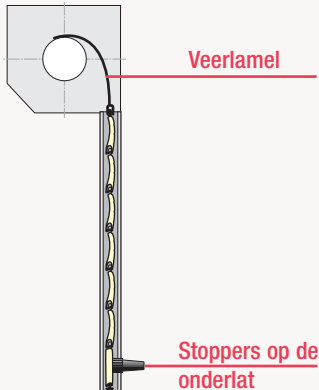

Enkel afstelling onderste punt → 6

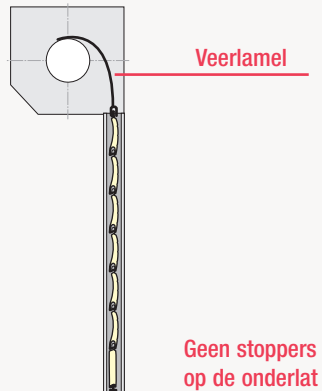

Manuele afstelling → 7

## AFSTELLEN OXIMO RTS MOTOR

**4** Automatische afstelling

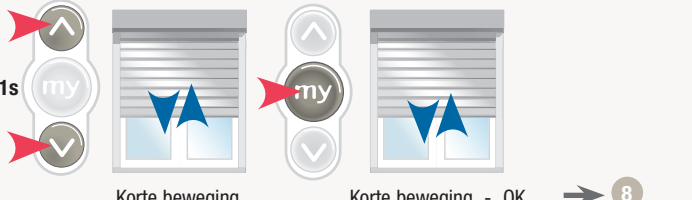

1s

Korte beweging

Korte beweging - OK → 8

**5** Enkel afstelling bovenste eindpunt



1s

STOP

1s

Bevestig de eindafstellingen

2s

Korte beweging - OK → 8

## AFSTELLEN OXIMO RTS MOTOR

6

Enkel afstelling onderste eindpunt

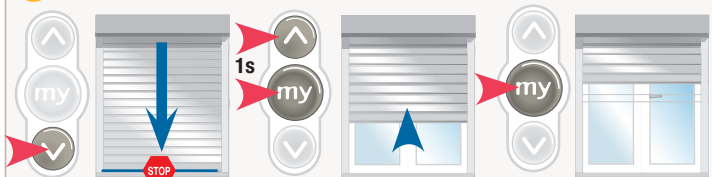

Bevestig de eindafstellingen

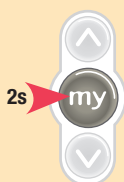

Korte beweging - OK

→ 8

## MANUELE AFSTELLING OXIMO RTS MOTOR

### 7 Afstelling onderste eindpunt

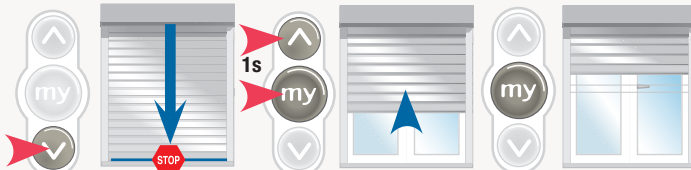

Plaats rolluik op onderste eindpunt

### Afstelling bovenste eindpunt

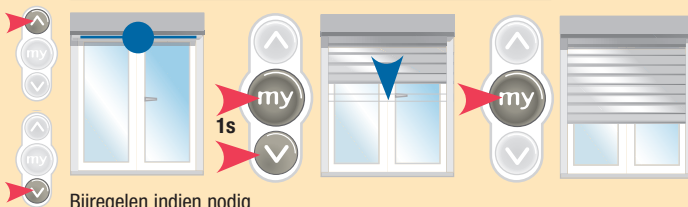

Bijregelen indien nodig

### Bevestig de eindafstellingen

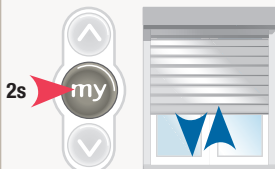

Korte beweging

### 8 Programmeren van een zender



Achterkant Centralis

Achterkant Telis

Korte beweging → OK

## PROGRAMMEERTOETS

### Plaats programmeertoets op de zenders



Telis afstandsbediening

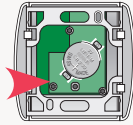

Centralis RTS



Chronis RTS



Soliris RTS en  
Eolis RTS sensoren

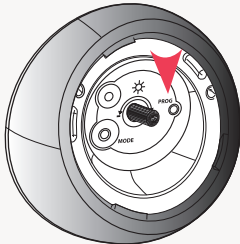

Sunis sensor RTS

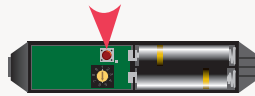

Eolis 3D Wirefree RTS

### Plaats programmeertoets op de ontvangers

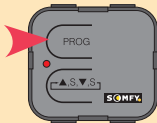

Centralis Indoor RTS  
Drape 7070 module  
Lighting indoor RTS

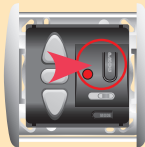

Centralis Uno RTS  
Centralis Uno RTS VB

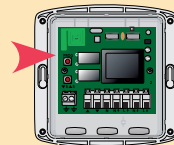

Universal Receiver



## TOEVOEGEN VAN EEN ZENDER

### 1 Open het geheugen van de ontvanger

Reeds  
geprogram-  
meerde  
zender

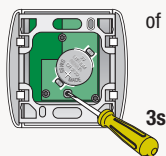

of



3s



Centralis

Achterkant Telis

Korte beweging

### 2 Deze handeling moet gebeuren binnen de 2 min. na het openen van het geheugen

Toe te  
voegen  
zender

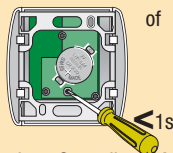

of



<1s



Achterkant Centralis

Achterkant Telis

Korte beweging

→ OK

### 1 Open het geheugen van de ontvanger met een Inis RT

Reeds  
geprogram-  
meerde  
INIS RT

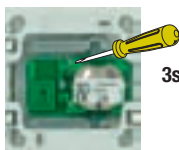

3s



Contact tussen Prog en batterij

Korte beweging

### 2 Deze handeling moet gebeuren binnen de 2 min. na het openen van het geheugen

Toe te  
voegen  
zender

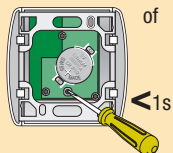

of



<1s



Centralis

Achterkant Telis

Korte beweging

→ OK

## VERWIJDEREN VAN EEN ZENDER

### 1 Open het geheugen van de ontvanger

**Te  
behouden  
zender**

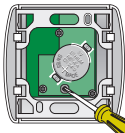

of



3s



Achterkant Centralis

Achterkant Telis

Korte beweging

### 2 Deze handeling moet gebeuren binnen de 2 min. na het openen van het geheugen

**Te  
verwijderen  
zender**

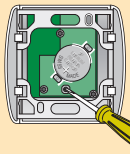

of



<1s



Achterkant Centralis

Achterkant Telis

Korte beweging

→ OK

### 1 Open het geheugen van de ontvanger

**Te  
behouden  
zender**

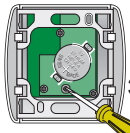

ou



3s



Achterkant Centralis

Achterkant Telis

Korte beweging

### 2 Deze handeling moet gebeuren binnen de 2 min. na het openen van het geheugen

**INIS  
RT  
te verwijde-  
ren**

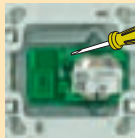

<1s



Contact tussen Prog en batterij

Korte beweging → OK

## TOEVOEGEN KEYGO

### 1 Open de Keygo



Draai de beide schroeven los en open de achterzijde



### 2 Gebruik de geprogrammeerde RTS bediening



3s



Korte beweging

### 3 Zet de zender in programmeerstand



<1s



LED aan de voorzijde knippert

### 4 Programmeer het gewenste kanaal



Druk kort op de gewenste bedieningstoets



# AANPASSEN VAN DE EINDPUNTEN

## 1 Aanpassen van het onderste eindpunt

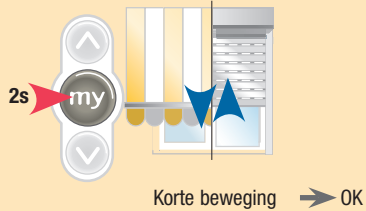
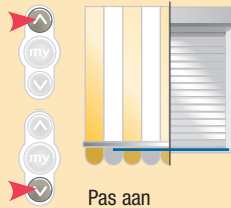
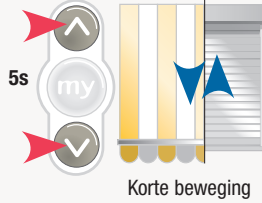
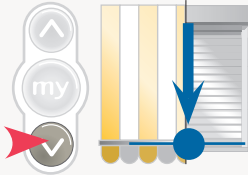

## 2 Aanpassen van het bovenste eindpunt

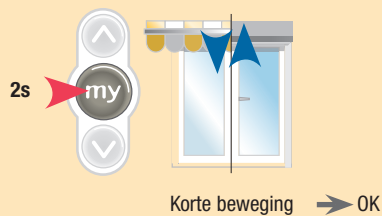
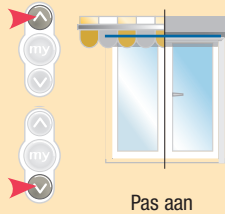
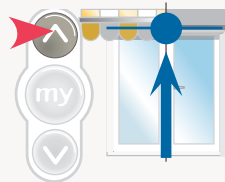

## AFSTELLEN VAN DE TUSSENPOSITIE\*

(OP ALTUS RTS OREA RTS OXIMO RTS)

**1 Bevestigen of aanpassen**

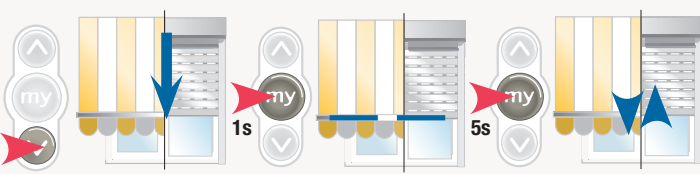

1s 5s

Korte beweging → OK

**2 Verwijderen**

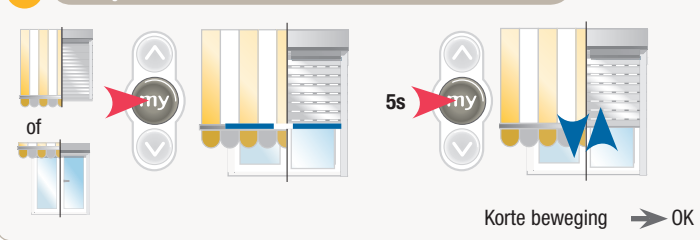

5s

Korte beweging → OK

**3 Gebruik**

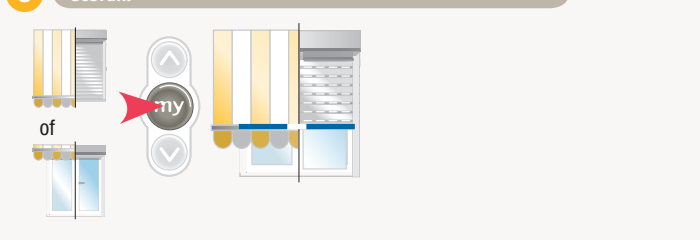

\*Tussenpositie : bijvoorbeeld "daglichtstand" of bescherming van binnen tegen de zon.

# BACK-IMPULS FUNCTIE

(OPSPANNEN VAN HET DOEK BIJ DE OREA RTS VANAF 2006)

## Instellen van de Back-impuls functie

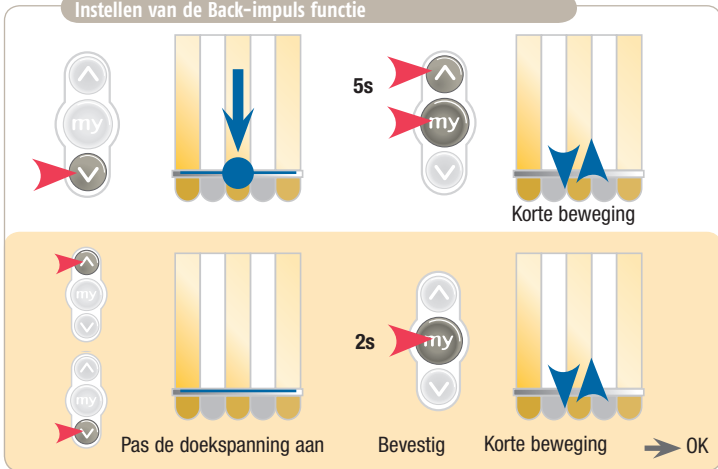

## Wissen van de Back-impuls functie

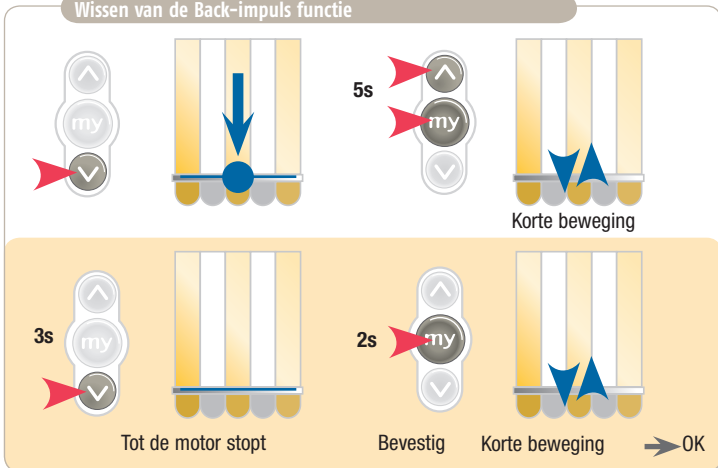

OPM: een dubbele spanningsonderbreking + 7s op de prog toets drukken van de zender wist de Back-impuls instelling niet.

## OMKEREN VAN DE DRAAIRICHTING

(OXIMO RTS 2009)

### 1 Plaats het rolluik in het midden



OK



NIET OK

### 2 Neem de controle over de motor

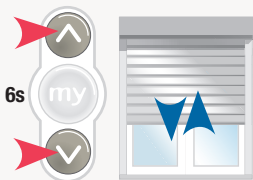

### 3 Verander de draairichting

Dit moet binnen de 5 seconden gebeuren.

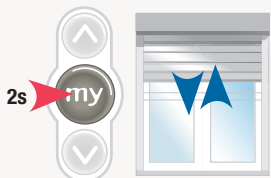

Korte beweging → OK

## GEHEUGEN GEDEELTELIJK WISSEN

### 1 Open het geheugen met een dubbele spanningsonderbreking

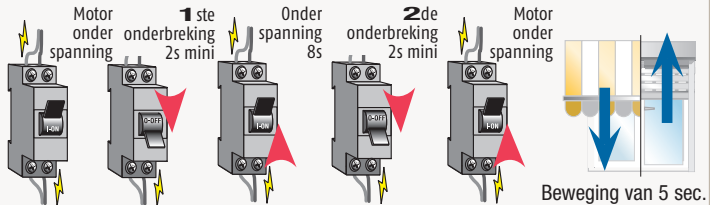

**Alleen een dubbele spanningsonderbreking uitvoeren op de betrokken motor**

### 2 Programmeer de nieuwe zender



De zender is geprogrammeerd en alle andere zenders zijn gewist.



## GEHEUGEN VOLLEDIG WISSEN

### 1 Open het geheugen met een dubbele spanningsonderbreking

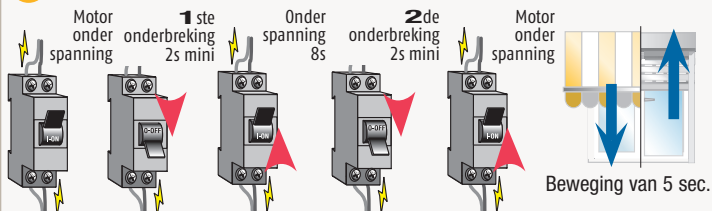

**Alleen een dubbele spanningsonderbreking uitvoeren op de betrokken motor**

### 2 Zet de motor terug in het fabrieksstand

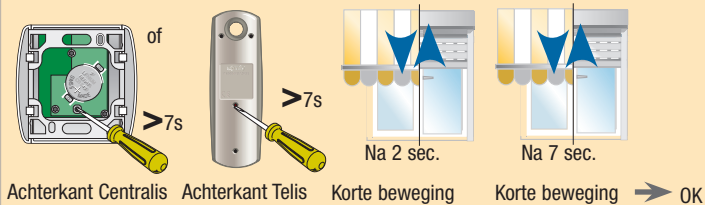

\*Blijven duwen tot 2<sup>de</sup> korte beweging

## PROGRAMMEREN VAN EEN ONTVANGER

### 1 Programmatietoets

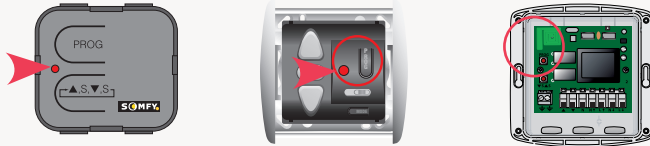

### 2 Open het geheugen van de ontvanger



3 sec.

Druk 3 sec. op de programmatietoets van de ontvanger



Het lampje van de ontvanger brand

### 3 Programmeren van een zender

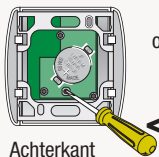

<1s

Achterkant Centralis

of



<1s

Achterkant Telis

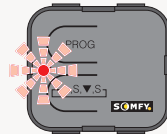

Het lampje van de ontvanger gaat knipperen

### 4 Wissen van het geheugen van de ontvanger



10 sec.

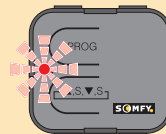

Het lampje van de ontvanger gaat knipperen voor het doven

# BEDRADINGSSCHEMA

Centralis Indoor RTS

Bedrade motor

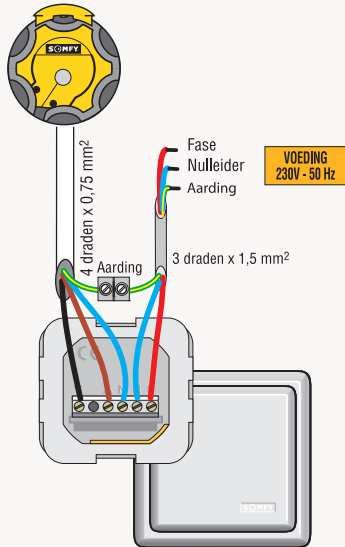

# BEDRADINGSSCHEMA

Centralis Uno RTS

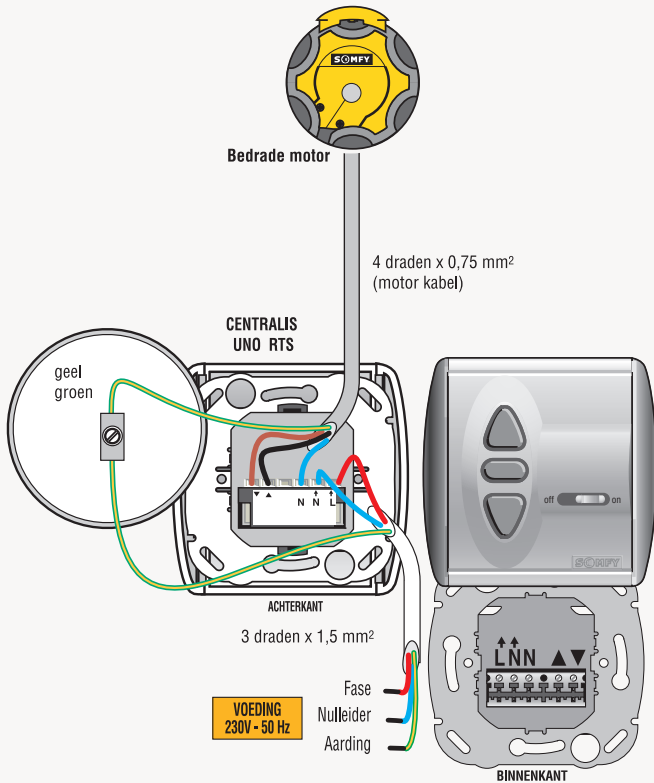

## BEDRADINGSSCHEMA

Universal Receiver RTS

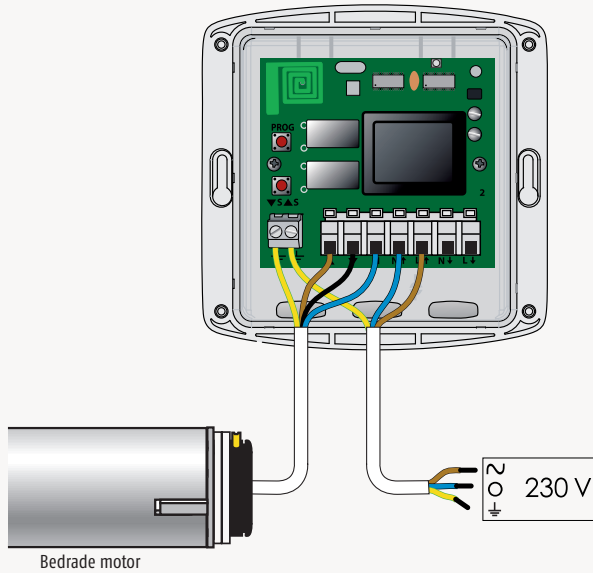

## INSTELLEN VAN DE ZONWAARDE

Alleen de Soliris zender kan de zon-functie activeren.

Hulp bij het instellen van de van de Sunis sensor RTS

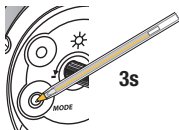
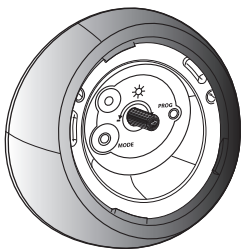

Demo modus activeren



De kleur van de LED varieert in functie van de ingestelde drempelwaarde in verhouding met de gemeten lichtsterkte.

- LED groen: de huidige lichtsterkte is voldoende om het scherm of rolluik neer te laten.

- LED rood: de huidige lichtsterkte is niet voldoende om het scherm of rolluik neer te laten.

Demo modus verlaten gebeurt: - door op demo te drukken.  
- automatisch na 3 minuten.

Instellen van de potentiometer

gevel zuid/west

gevel oost/noord

Stel de gevoeligheid in op de sensor volgens de geografische ligging

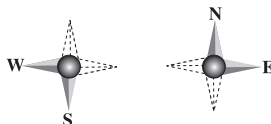
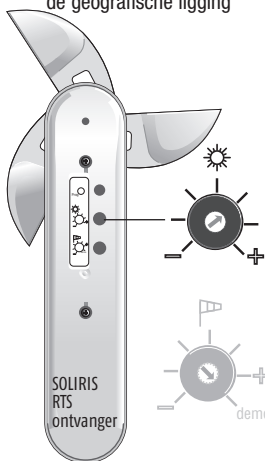

ik zit graag in de zon



Ik hou van de zon maar ik bescherm mij

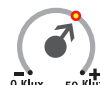
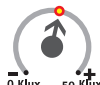

Ik verkies steeds om in de schaduw te zitten

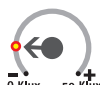

## EOLIS 3D WIREFREE RTS - MONTAGE VAN HET PRODUCT

### Plaatsen van de batterijen



Open het product

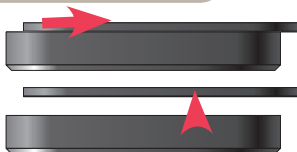

Haal het binnenwerk eruit



Plaats de batterijen  
De LED brandt gedurende 1s



### Montage van het product

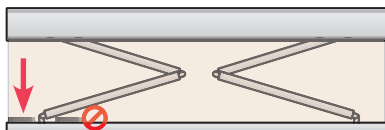
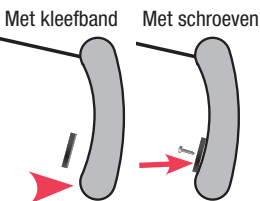

- ! > Plaatsen gebeurt bij voorkeur aan de uiteinde van de voorlijst. (meest gevoelig aan trillingen)
- > Opgelet bij het plooiën van de armen.
- > **NIET** in de wand van de voorlijst.

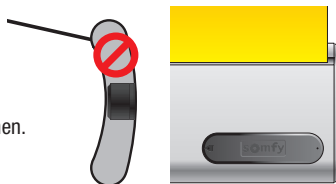

## EOLIS 3D WIREFREE RTS

Programmatie - (Nadat de sensor gemonteerd werd)

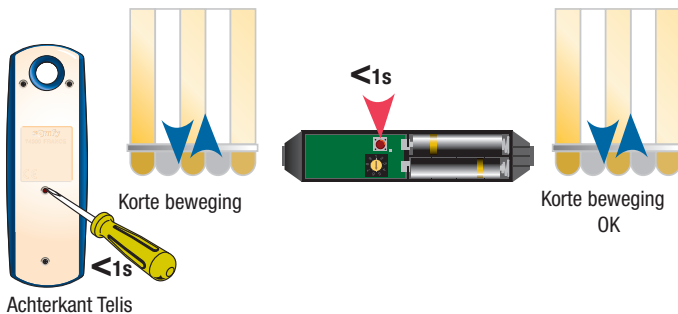

Instelling van de drempelwaarde (1 - Via de potentiometer)

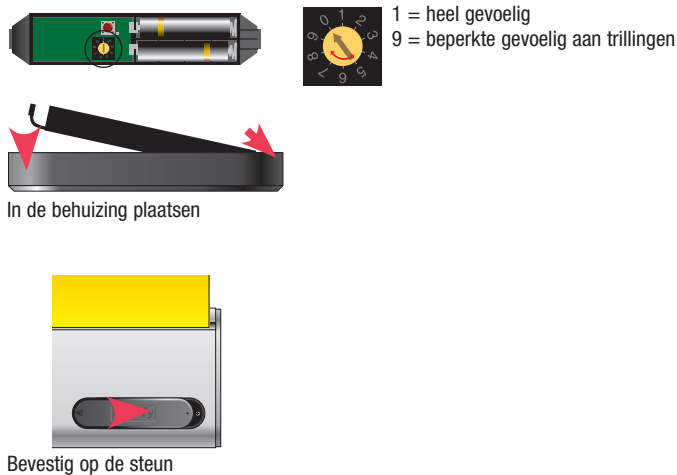



## EOLIS 3D WIREFREE RTS

Instelling van de drempelwaarde (2 - persoonlijke instelling)

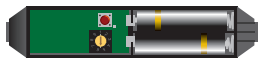

Stel in op 0



..en plaats de sensor in de  
behuizing

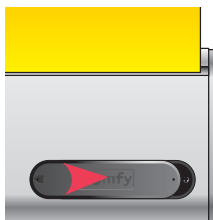

Bevestig de Eolis 3D  
op steun



...totdat het scherm naar binnen rolt



## AFSTELLEN LS 40 MOTOREN

1

De opwaartse richting noteren alvorens u het rolluik of doek op de as plaatst

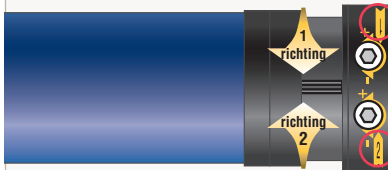

INFO :

De motoren worden door Somfy geleverd met een fabrieksinstelling van 3 toeren.

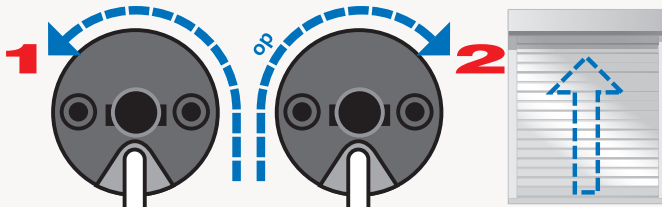

Vind de draaistift (richting 1 of 2) die overeenstemt met de opgaande richting van het rolluik (of de zonnetent)

2

Bekabeling

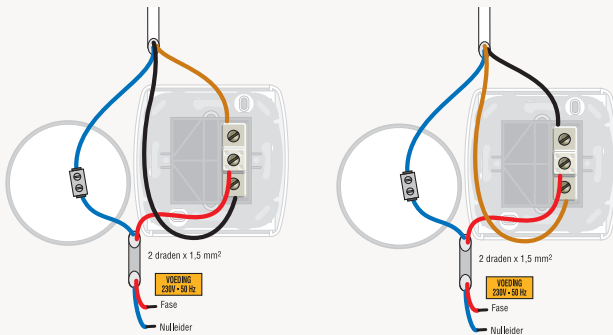

In het geval dat de neer knop een opwaartse beweging geeft, moet u de bruine en zwarte kabel verwisselen.

## AFSTELLEN LS 40 MOTOREN

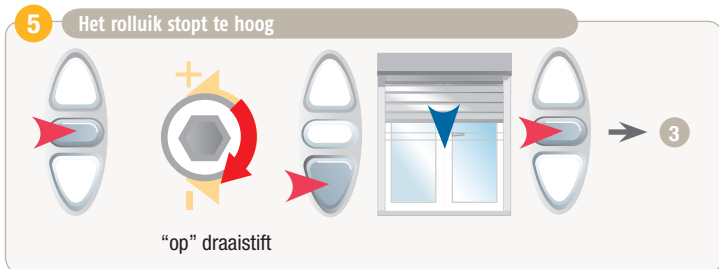
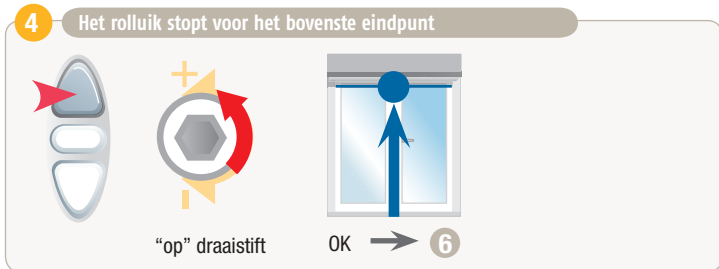
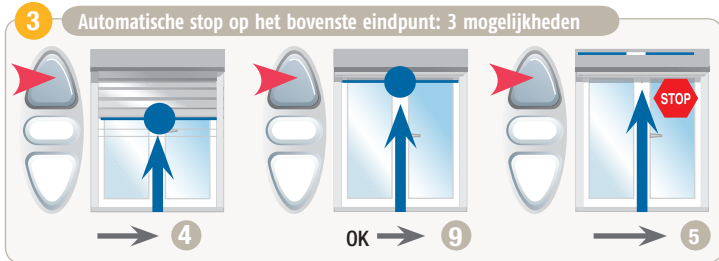

## AFSTELLEN LS 40 MOTOREN

### 6 Automatische stop op het onderste eindpunt: 3 mogelijkheden

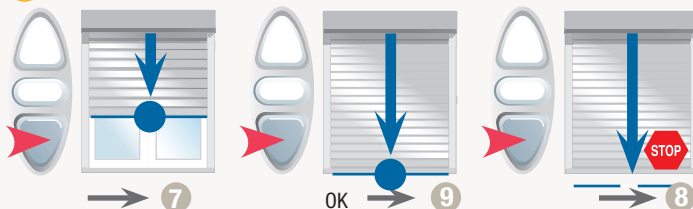

### 7 Het rolluik stopt voor het onderste eindpunt

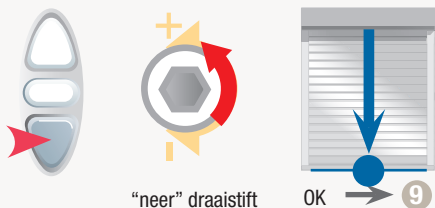

### 8 Het rolluik stopt te laag

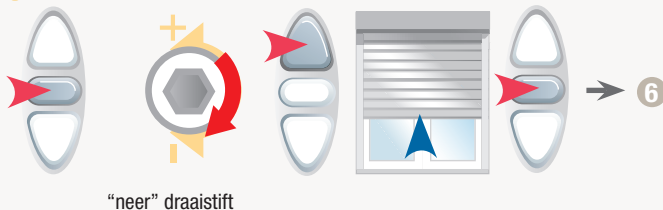

### 9 Test



## AFSTELLEN LT50 - LT60 - LT50 CSI - LT60 CSI MOTOREN

### 1 Voorbereiding

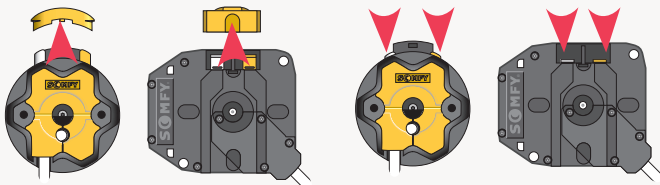

Wissen van de eindpunten

### 2 Bekabeling

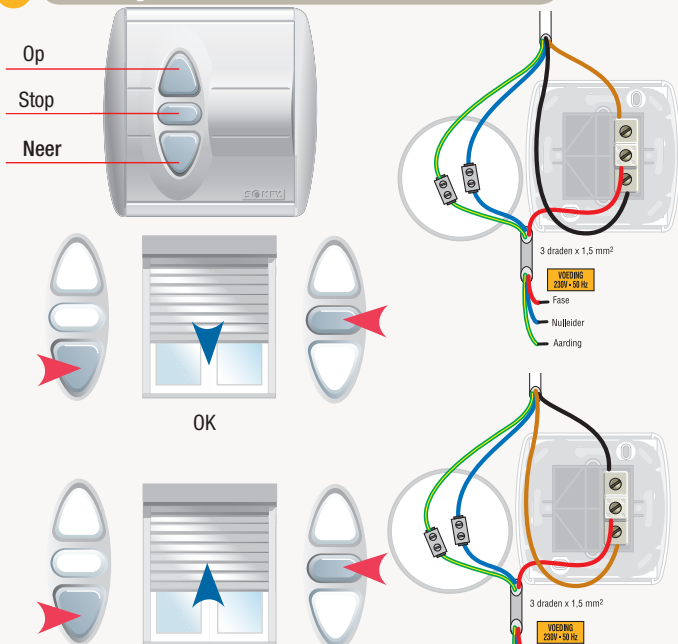

In het geval dat de neer knop een opwaartse beweging geeft, moet u de bruine en zwarte kabel verwisselen.

## AFSTELLEN LT50 - LT60 - LT50 CSI - LT60 CSI MOTOREN

### 3 Afstelling van het onderste eindpunt

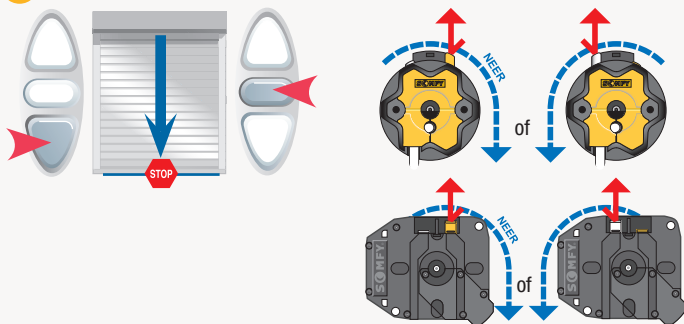

### 4 Afstelling van het bovenste eindpunt

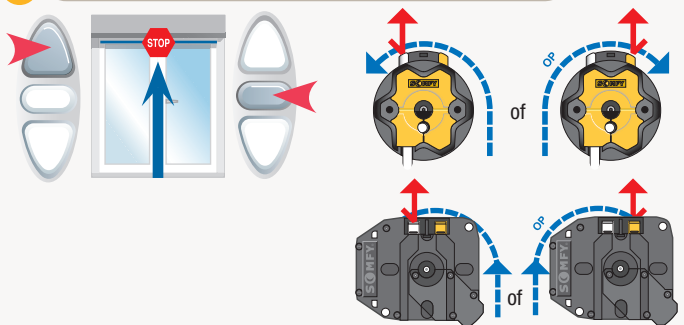

### 5 Test

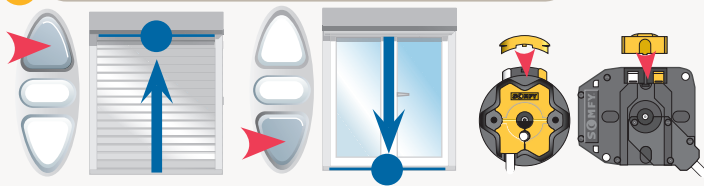

## AFSTELLEN SLT 50 – SLT 60 MOTOREN

### 1 Voorbereiding

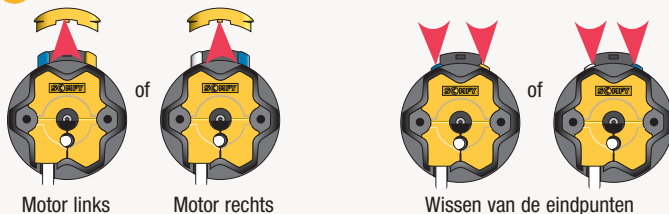

### 2 Bekabeling

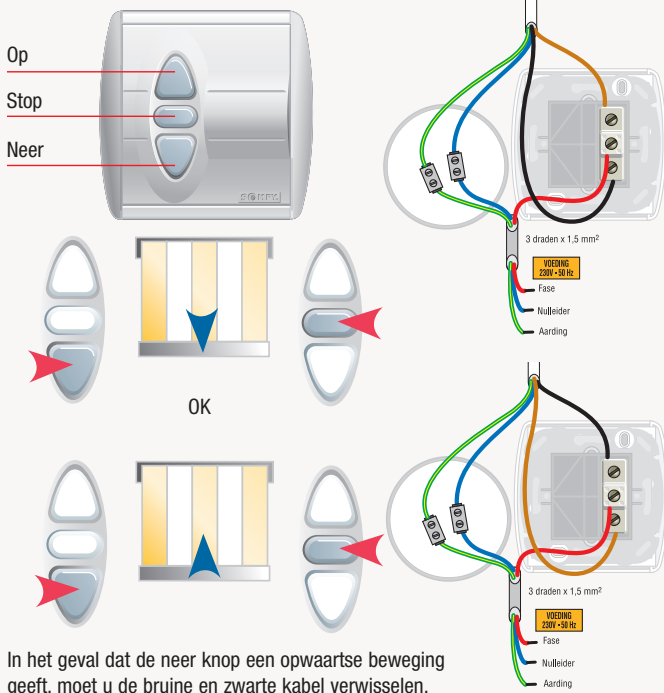

## AFSTELLEN SLT 50 – SLT 60 MOTOREN

3

Afstellen van het onderste eindpunt

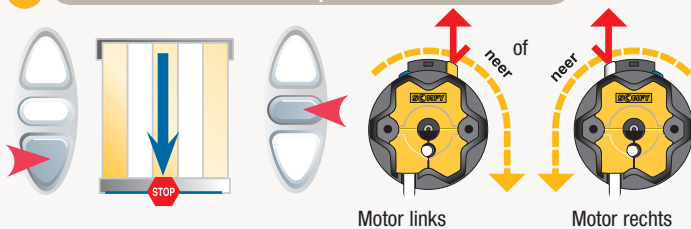

4

Afstellen van het bovenste eindpunt

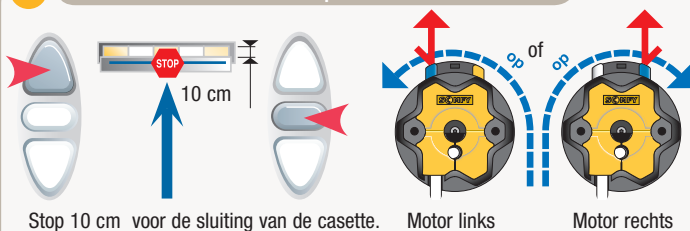

5

Test

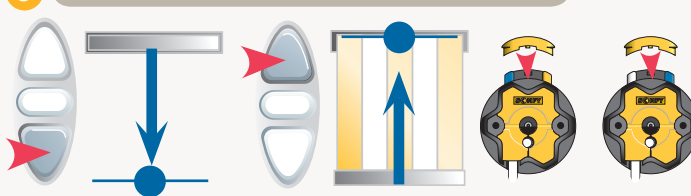



## AFSTELLEN OREA WT

- 1** Sluit de motor aan op de Setting Tool WT

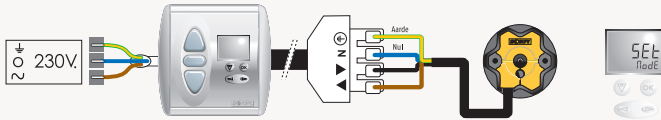

- 2** Controleer de draairichting



Druk kort op OK

OK → **4**

Niet OK → **3**

- 3** Wijzig de draairichting, indien nodig



Wissel de bruine en zwarte motordraad om

## AFSTELLEN OREA WT

### 4 Bevestig de draairichting

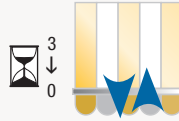
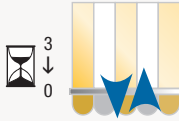

Druk kort op OK

Na 3 sec. korte beweging

Na 3 sec. weer een korte beweging

### 5 Afstellen van de onderste eindpositie

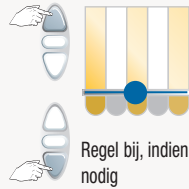

Druk kort op ►

Stuur eindproduct naar onderste eindpositie

Regel bij, indien nodig

### 6 Bevestigen onderste eindpositie

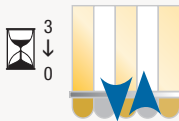

Druk kort op OK

Na 4 sec. korte beweging

Eindproduct stuurt automatisch omhoog

### 7 Sluit leerproces af

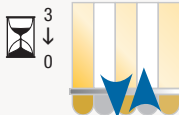

Druk kort op OK

Na 3 sec. korte beweging

## AANPASSEN ONDERSTE EINDPOSITIE VAN DE OREA WT

- 1 Sluit de motor aan op de Setting Tool WT

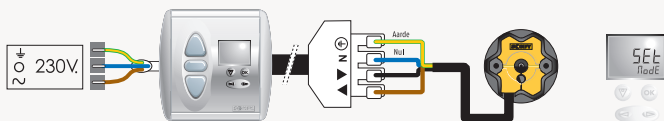

- 2 Controleer de draairichting

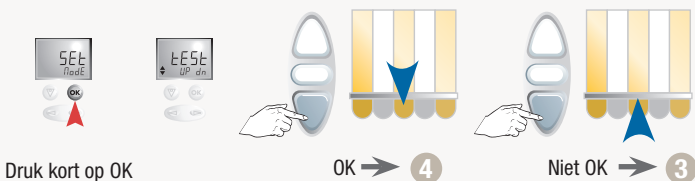

- 3 Wijzig de draairichting, indien nodig

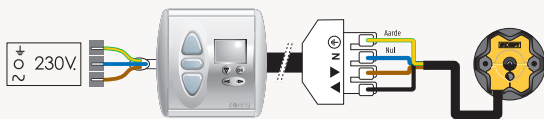

Wissel de bruine en zwarte motordraad om

## AANPASSEN ONDERSTE EINDPOSITIE VAN DE OREA WT

### 4 Selecteer modus om eindpositie aan te passen



Druk kort op M



Druk kort op M



Druk kort op M



Druk op OK



Druk kort op ►



Druk kort op ►



Stuur eindproduct naar onderste eindpositie

### 5 Verwijder onderste eindpositie



Druk kort op OK

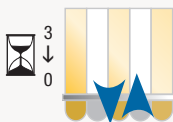

Na 3 sec. korte beweging



### 6 Kies en bevestig nieuwe onderste eindpositie



Kies nieuwe onderste eindpositie



Druk op OK



Na 4 sec. korte beweging



Eindproduct stuurt automatisch omhoog

## AANPASSEN ONDERSTE EINDPOSITIE VAN DE OREA WT

7

Sluit af



Druk kort op OK

## AFSTELLEN OXIMO WT

### 1 Sluit de motor aan op de Setting Tool WT

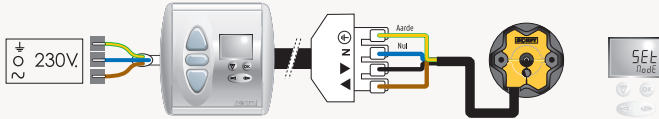

### 2 Controleer de draairichting



OK → 4



Niet OK → 3

Druk kort op OK

### 3 Wijzig de draairichting, indien nodig

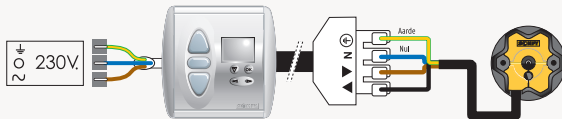

Wissel de bruine en zwarte motordraad om

## AFSTELLEN OXIMO WT

4

Bevestig de draairichting



Druk kort op OK



Na 3 sec. korte beweging



Na 3 sec. weer een korte beweging



Keuzetabel

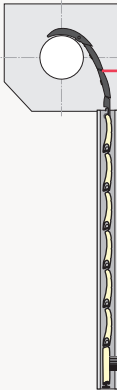

Anti optil  
accessoire

Voldoende aanslag  
in bovenpunt

Volledig automatisch inregelen → 5

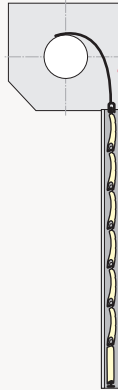

Flexibele veer

Onvoldoende aanslag  
in bovenpunt

Handmatig inregelen → 6

## AFSTELLEN OXIMO WT VOLLEDIG AUTOMATISCH INREGELEN

5

Volledig automatisch inregelen van rolluiken die voorzien zijn van anti-optilaccessoires en stoppers



Druk kort op ►



Druk kort op ►



Druk kort op OK



Na 3 sec. korte beweging



### Automatisch bepalen onderste eindpositie



Kort



Motor stopt  
zelf onderaan

### Automatisch bepalen bovenste eindpositie



Kort



Motor stopt  
zelf bovenaan



Druk op OK





## AFSTELLEN OXIMO WT

### HANDMATIG INREGELEN

6

#### Handmatig inregelen



#### Inregelen bovenste eindpositie

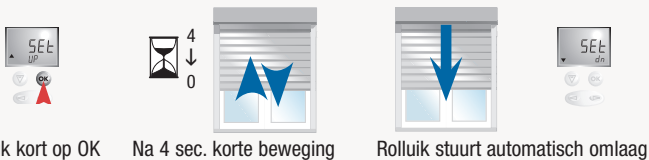

#### Inregelen onderste eindpositie

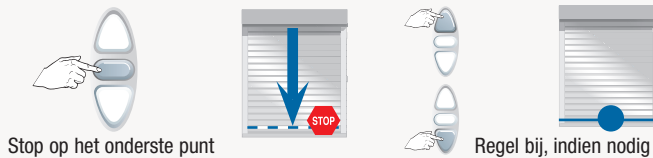

7

#### Sluit leerproces af

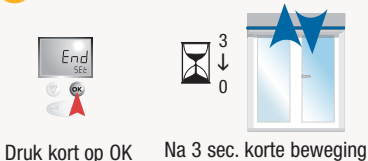

## AANPASSEN EINDPOSITIE OXIMO WT BIJ MANUELE INSTELLING

- 1** Sluit de motor aan op de Setting Tool WT

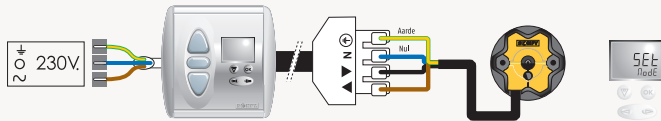

- 2** Controleer de draairichting



Druk kort op OK

OK → **4**

Niet OK → **3**

- 3** Wijzig de draairichting, indien nodig

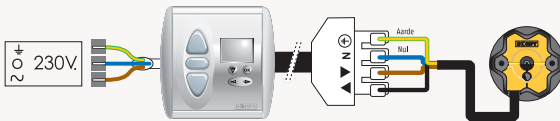

Wissel de bruine en zwarte motordraad om

## AANPASSEN EINDPOSITIE OXIMO WT BIJ MANUELE INSTELLING

- 4** Aanpassen bovenste eindpositie: Ga naar 5  
Aanpassen onderste eindpositie: Ga naar 6

- 5** Aanpassen bovenste eindpositie  
Verwijder bestaande bovenste eindpositie



Druk kort op M



Druk kort op M



Druk kort op M



Druk op OK



Druk kort op ►



Kort



Stuur rolluik naar  
bovenste eindpositie



Druk kort op OK



Na 3 sec. korte beweging



Kies nieuwe bovenste eindpositie



Toets vasthouden, laat los op gewenste positie

## AANPASSEN EINDPOSITIE OXIMO WT BIJ MANUELE INSTELLING



Druk op OK



Na 4 sec. korte beweging



Rolluik stuurt automatisch omlaag



Druk kort op STOP

**Stop neergaande beweging rolluik**



Druk kort op ►

Sluit af



Druk op OK



Druk op OK

## AANPASSEN EINDPOSITIE OXIMO WT BIJ MANUELE INSTELLING

6

Aanpassen onderste eindpositie  
Verwijder bestaande bovenste eindpositie



Druk kort op M



Druk kort op M



Druk kort op M



Druk op OK



Druk kort op ►



Druk kort op ►



Kort



Stuur rolluik naar  
onderste eindpositie



Druk kort op OK



Na 3 sec. korte beweging



## AANPASSEN EINDPOSITIE OXIMO WT BIJ MANUELE INSTELLING

Kies nieuwe onderste eindpositie



Toets vasthouden, laat los op gewenste positie



Druk kort op OK

Na 4 sec. korte beweging

Rolluik stuurt automatisch omhoog



Druk kort op STOP



Stop opgaande beweging rolluik

Sluit af



Druk op OK



Druk op OK

# VOLLEDIG WISSEN VAN HET GEHEUGEN VAN DE OREA WT OF OXIMO WT

## 1 Sluit de motor aan op de Setting Tool WT

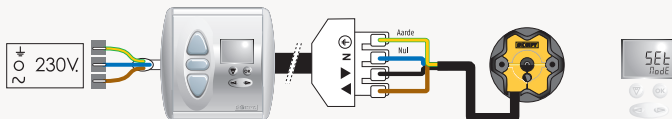

## 2 Selecteer modus om te wissen



Druk kort op M



Druk kort op M



Druk op OK

## 3 Verwijder alle instellingen



Druk op OK

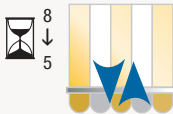

Na 4 sec. korte beweging

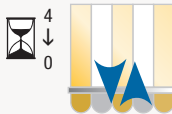

Na 4 sec. weer een korte beweging



Start venster

**Alle instellingen zijn gewist. De motor kan opnieuw ingeregeld worden.**

## HERKENNEN VAN DE OREA WT OF OXIMO WT MOTOR

### 1 Sluit de motor aan op de Setting Tool WT



### 2 Selecteer controlemenu



Druk kort op M



Druk kort op M



Druk kort op M



Druk op OK



Stuur product gedeeltelijk open



Kort



Druk kort op OK



## HERKENNEN VAN DE OREA WT OF OXIMO WT MOTOR



Na 5 sec. geen beweging

Niet afgestelde WT motor



Na 5 sec. korte beweging

Afgestelde WT motor

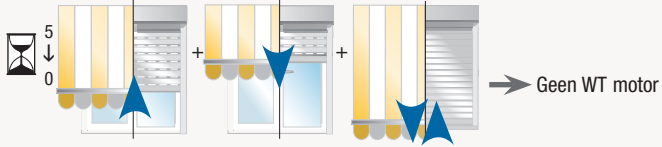

Binnen 5 sec. 4 x 4 x

Geen WT motor



Bepaal op basis van het resultaat de vervolghandeling

Druk kort op M

# BEDRADINGSSCHEMA

Inis Uno

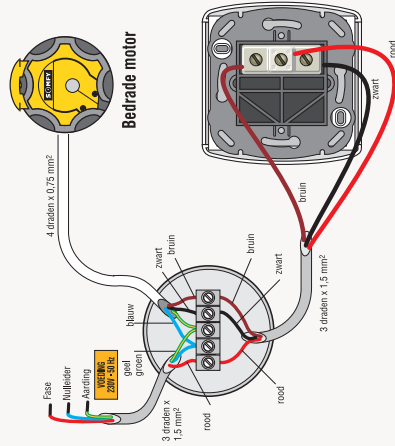
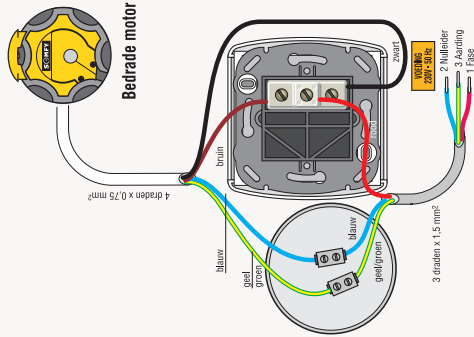

# BEDRADINGSSCHEMA

Inis Duo

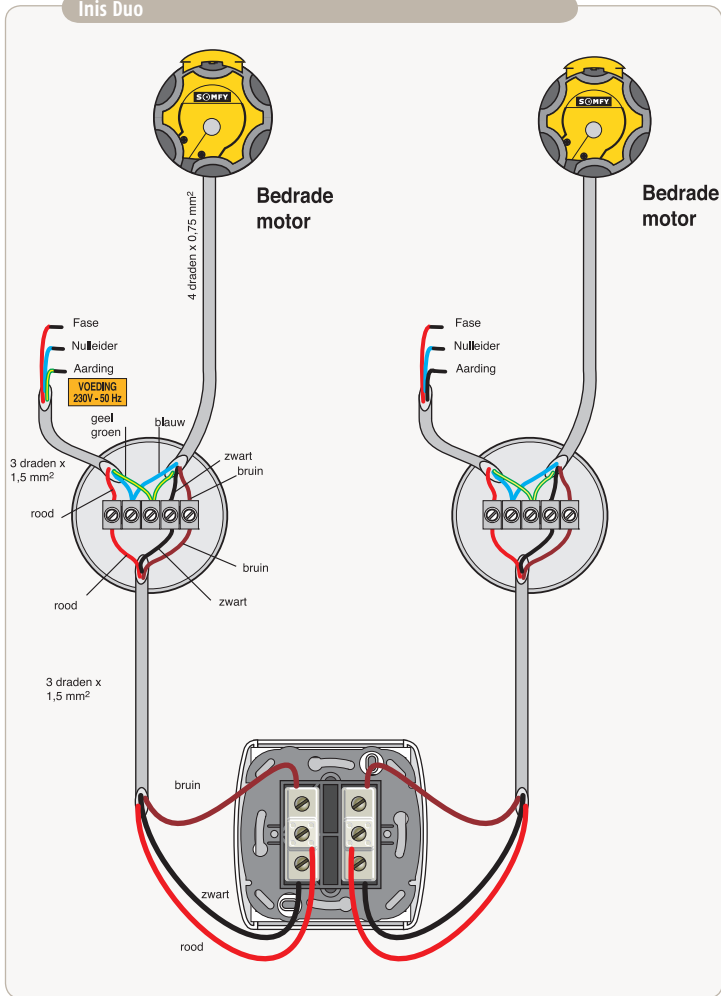

# BEDRADINGSSCHEMA

RK1

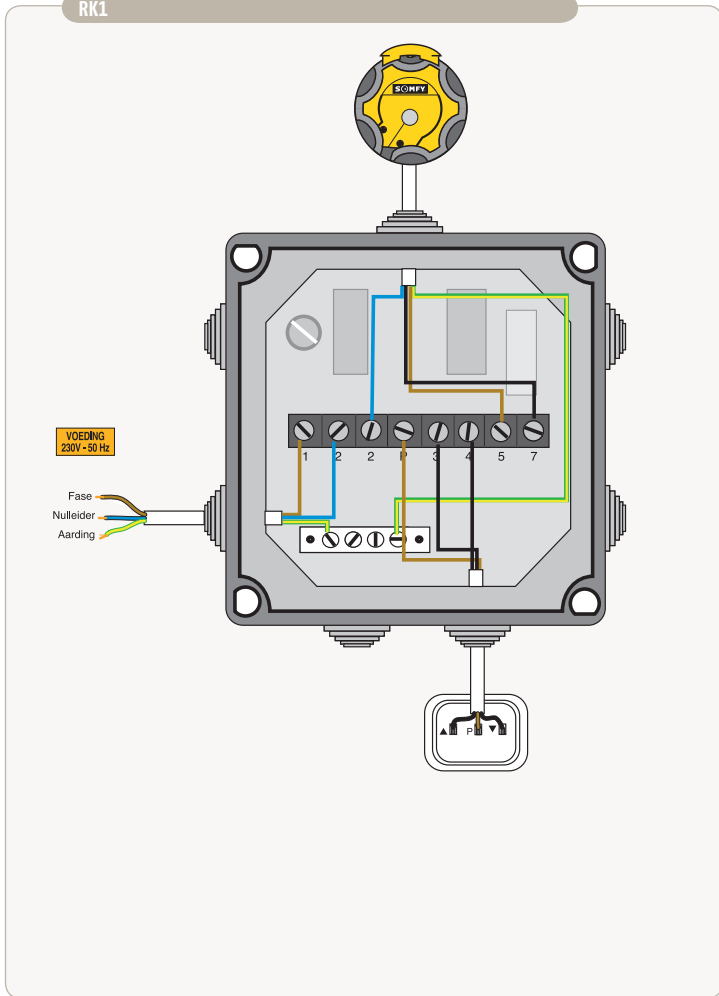

# BEDRADINGSSCHEMA

RK2

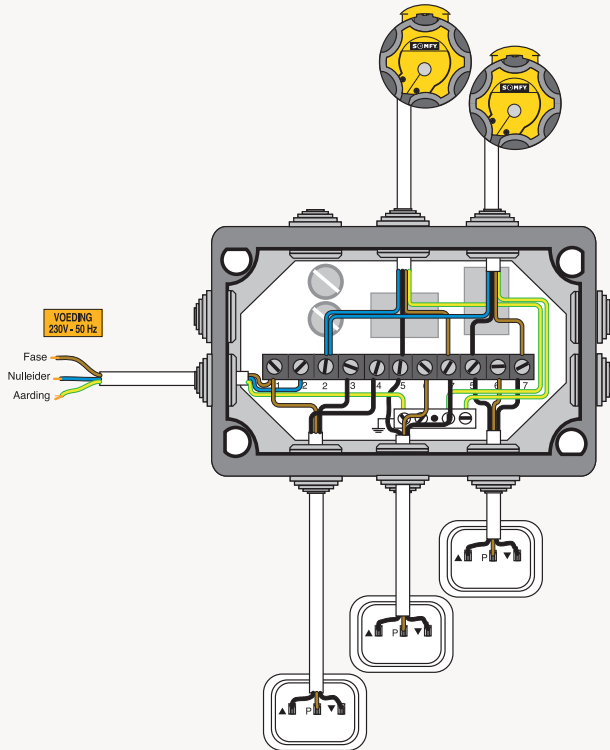

# BEDRADINGSSCHEMA

RK3

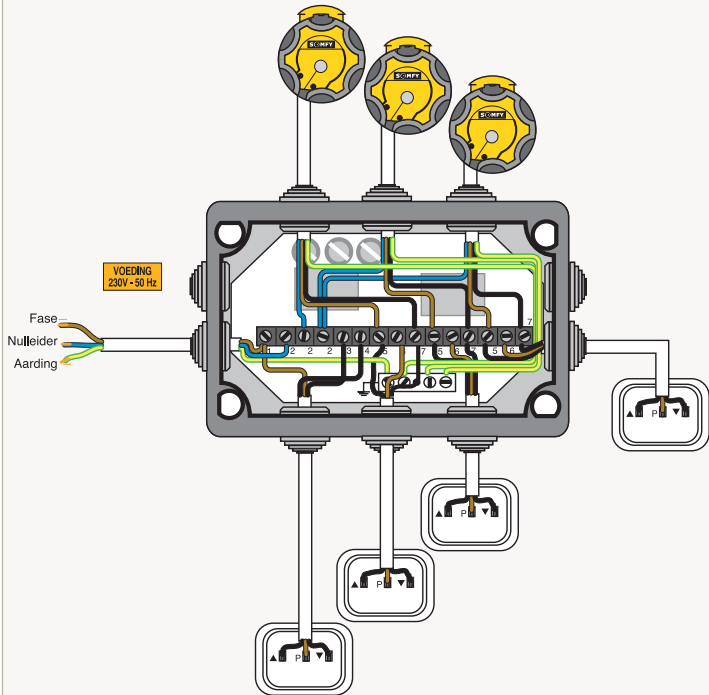

# BEDRADINGSSCHEMA

Parallel aansluiting voor relaiskasten

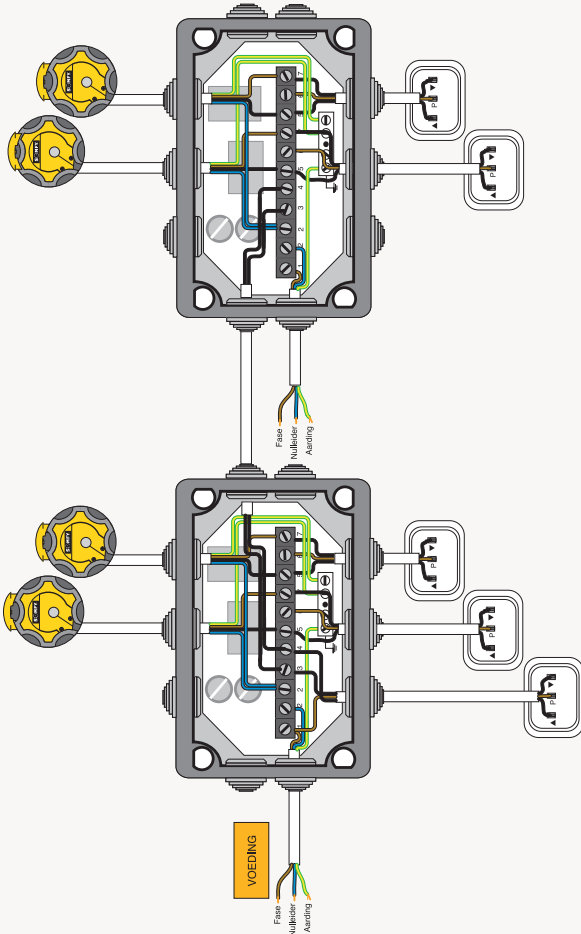

# BEDRADINGSSCHEMA

Cascade aansluiting voor relaiskasten

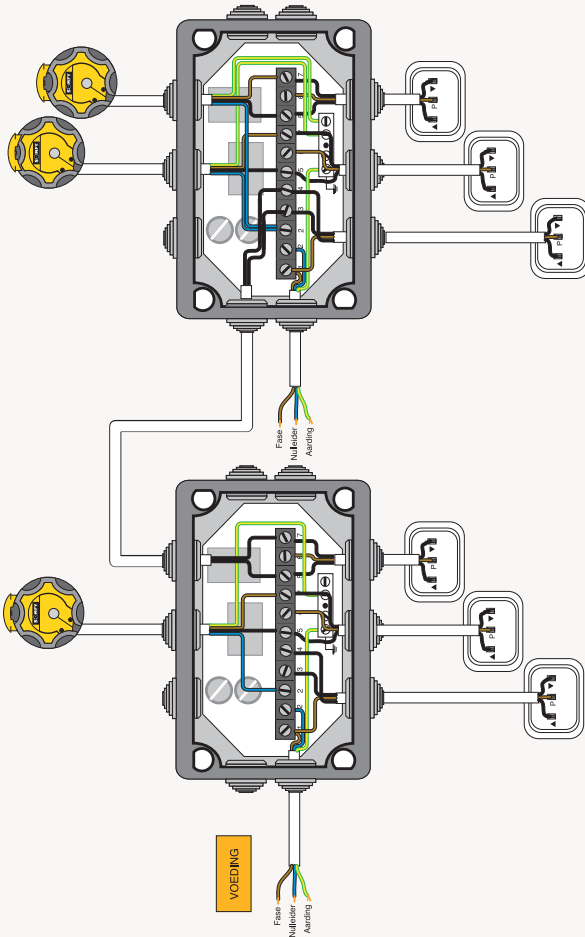



# BEDRADINGSSHEMA

## Mini Relaiskast

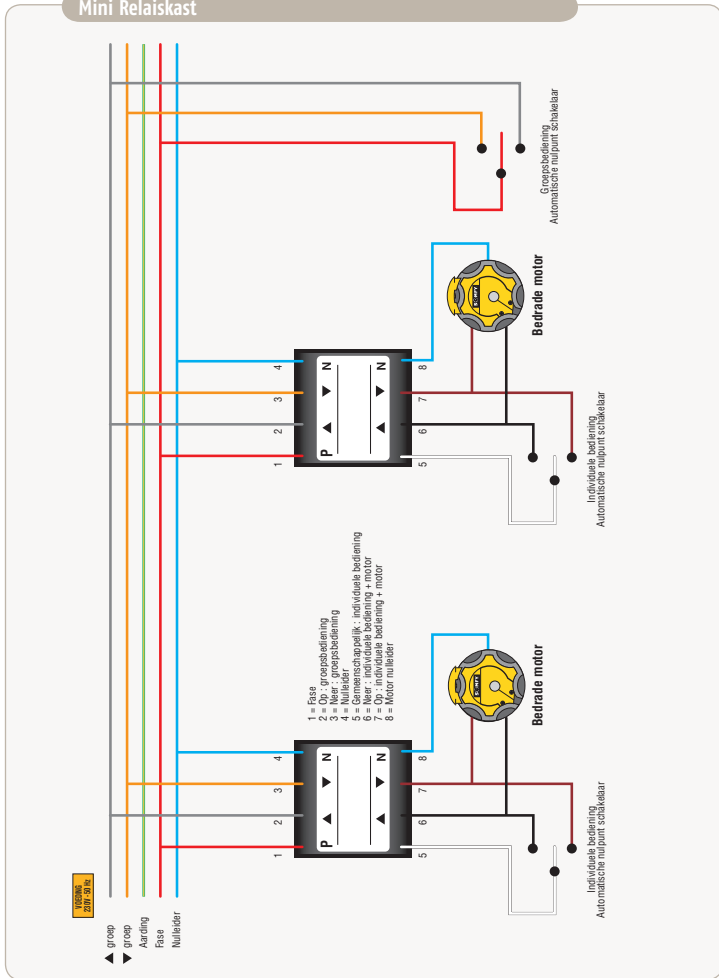

## BEDRADINGSSCHEMA

Chronis Easy / Smart / Comfort - motor aansluiting

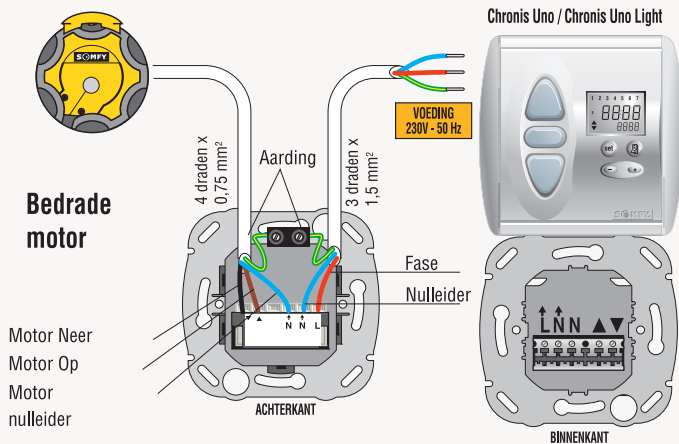

# BEDRADINGSSCHEMA

Eolis Box

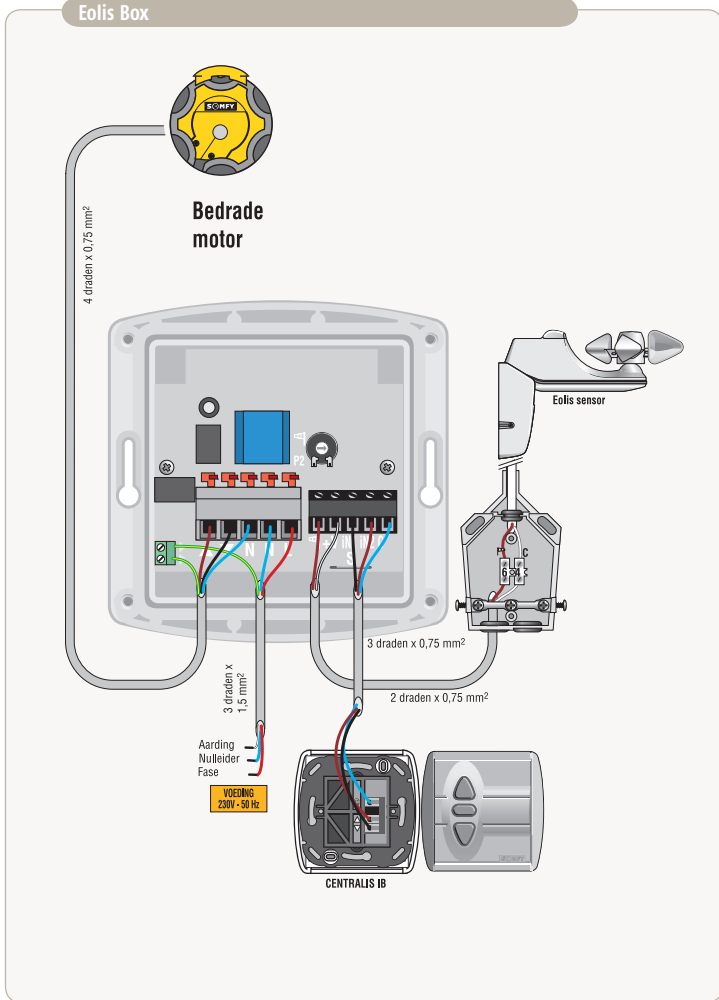

# BEDRADINGSSCHEMA

RK2 met klok Chronis Uno

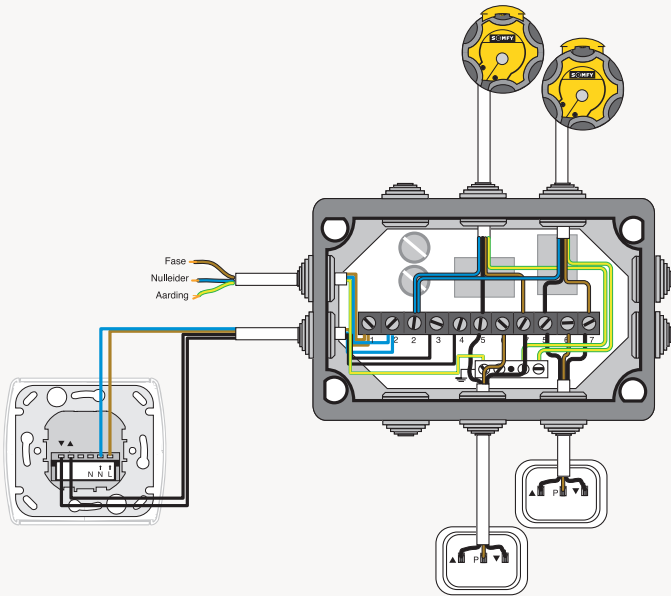

# BEDRADINGSSCHEMA

Soliris Uno

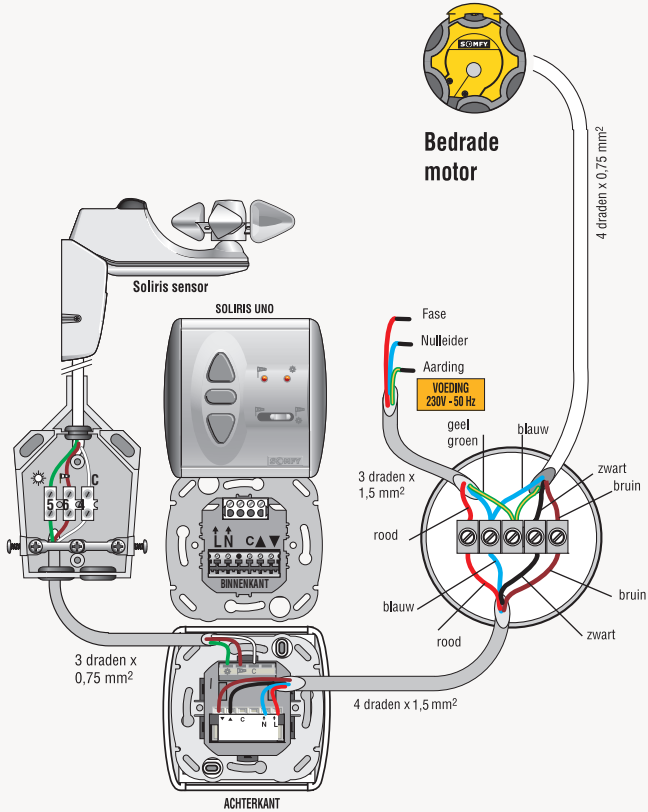

# BEDRADINGSSCHEMA

RK2 met zon/wind sensor Soliris Uno

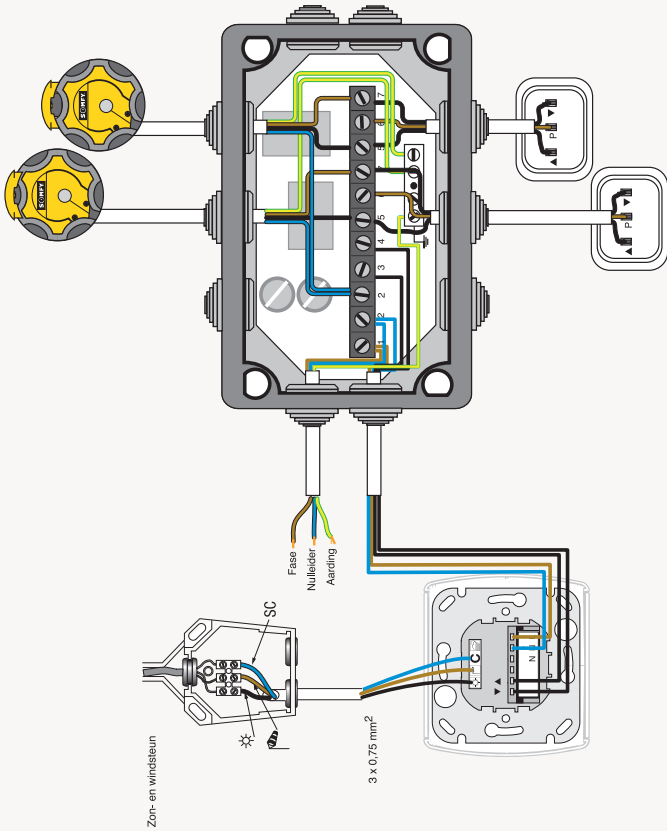

## CHRONIS EASY

### Display en toetsen

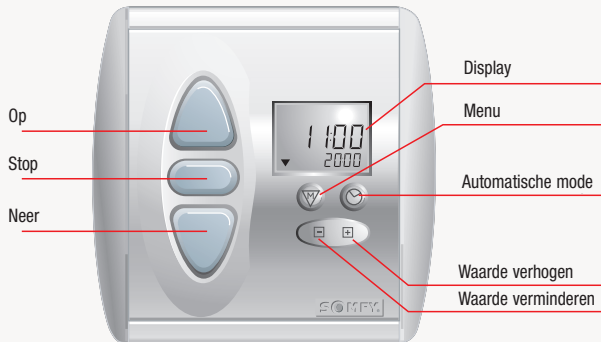

## INSTELLING VOOR CHRONIS EASY UNO EN CHRONIS EASY RTS

INSTELLEN TIJD VOOR OP EN NEER

### Instellen huidige tijd



Begin scherm



Vasthouden tot CLOC  
verschijnt



Stel huidige tijd in

### Instellen van de OP tijd



kort indrukken,  
OP tijd knippert



Stel de OP tijd in

**GEEN OP tijd gewenst: kies dan de OFF tijd, deze komt na 23:59**

### Instellen van de NEER tijd



kort indrukken,  
NEER tijd knippert



Stel de NEER tijd in

**GEEN NEER tijd gewenst: kies dan de OFF tijd, deze komt na 23:59**

### Menu verlaten



Vasthouden tot  
beginscherm verschijnt



## INSTELLING VOOR CHRONIS EASY UNO EN CHRONIS EASY RTS

### Uitschakelen geprogrammeerde OP en NEER tijden



Vasthouden totdat OFF in display verschijnt  
Geprogrammeerde tijden voor OP en NEER zijn uitgeschakeld

### Inschakelen geprogrammeerde OP en NEER tijden



Vasthouden totdat schakeltijd in display verschijnt  
Geprogrammeerde tijden voor OP en NEER zijn ingeschakeld

## CHRONIS SMART UNO EN CHRONIS SMART RTS

### Toelichting display en functies van de toetsen

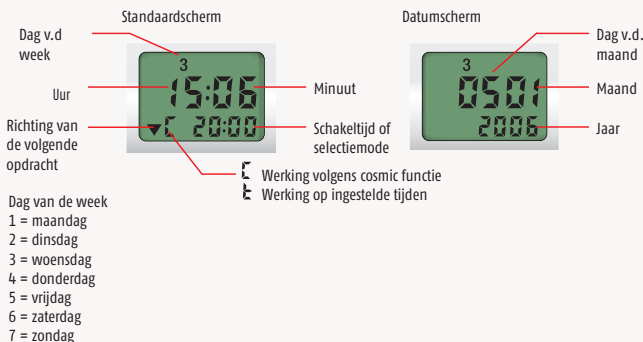
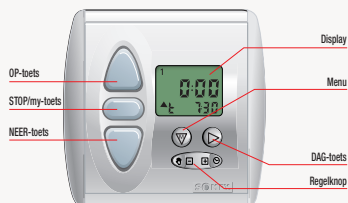

### Programmeerkeuzes



**Standaard weekprogramma**  
 Modus waarin voor iedere dag één tijd voor OP en NEER is te programmeren.



**SEC (Security) functie**  
 Functie waar de dag- en week- programmering wordt gebruikt en die de geprogrammeerde tijden met  $\pm 15$  min doet afwijken om aanwezigheid te simuleren.

## INSTELLINGEN VOOR CHRONIS SMART UNO EN CHRONIS SMART RTS

INST

### 1 Instellen huidige tijd



Begin scherm



Vasthouden tot CLOC verschijnt



Druk kort op dagtoets



De tijd knippert



Pas de tijd aan



Vasthouden tot begin scherm verschijnt

### 2 Instellen huidige datum



Begin scherm



Vasthouden tot CLOC verschijnt



Kort indrukken



Kort indrukken



De dag knippert



Pas de dag aan



Kort indrukken



De maand knippert



Pas de maand aan



Kort indrukken



Het jaar knippert



Pas het jaar aan



Vasthouden tot begin scherm verschijnt

## INSTELLINGEN VOOR CHRONIS SMART UNO EN CHRONIS SMART RTS

3

### Instellen van de OP tijd



Begin  
scherm



Vasthouden tot  
CLOC verschijnt



Kort indrukken



Kort indrukken



Kort indrukken



De dagen en de  
OP tijd knipperen



Kies alle dagen  
tegelijk of dag  
per dag



Pas de tijd voor  
OP aan



Kies eenvolgende dag met:    
stel de tijd in met: 

Herhaal dit voor alle  
gewenste OP tijden



Vasthouden tot begin scherm  
verschijnt. De instellingen  
zijn nu opgeslagen

**GEEN OP tijd gewenst op een bepaalde dag: kies dan de OFF tijd, deze komt na 23:59**

## INSTELLINGEN VOOR CHRONIS SMART UNO EN CHRONIS SMART RTS

INST

### 4.1 Instellen speling Cosmic NEER tijd



Begin scherm



Vasthouden tot CLOC verschijnt



Kort indrukken



Kort indrukken



Kort indrukken



Kort indrukken



Kort indrukken



De speling knippert



Stel de speling in



Kort indrukken

gewijzigde COSMIC tijd



Vasthouden tot begin scherm verschijnt  
De instellingen zijn nu opgeslagen

### 4.2 Uitschakelen COSMIC functie



Begin scherm



Vasthouden tot CLOC verschijnt



Kort indrukken



Kort indrukken



Kort indrukken



Kort indrukken



Kort indrukken



Time knippert



Vasthouden tot begin scherm verschijnt  
De instellingen zijn nu opgeslagen

Aanduiding neersturing op TIJD

## INSTELLINGEN VOOR CHRONIS SMART UNO EN CHRONIS SMART RTS

### 4.3 Instellen van de NEER tijd

Dit is alleen mogelijk als de COSMIC functie uitgeschakeld is



Begin scherm



Vasthouden tot CLOC verschijnt



Kort indrukken



Kort indrukken



Kort indrukken



Kort indrukken



Kort indrukken



De dagen en de NEER tijd knippen



Kies alle dagen tegelijk of dag per dag



Stel tijd voor NEER in



Herhaal dit voor alle gewenste NEER tijden



Kies eenvoudige dag met: Stel de tijd in met:

Vasthouden tot begin scherm verschijnt  
De instellingen zijn nu opgeslagen

**GEEN NEER tijd gewenst op een bepaalde dag: kies dan de OFF tijd, deze komt na 23:59**

### 4.4 Inschakelen COSMIC functie



Begin scherm



Vasthouden tot CLOC verschijnt



Kort indrukken



Kort indrukken



Kort indrukken



Kort indrukken



Kort indrukken



De COS functie knippert



Vasthouden tot begin scherm verschijnt

Gewijzigd naar COSMIC functie

## INSTELLINGEN VOOR CHRONIS SMART UNO EN CHRONIS SMART RTS

INST

### 5.1 Activeren van de SEC functie



Begin  
scherm



Vasthouden tot  
SEC verschijnt



SECurity  
functie actief

### 5.2 Uitschakelen van de SEC functie



Begin  
scherm



Vasthouden tot  
tijd verschijnt



Standaard  
functie actief

### 6.1 Uitschakelen van de geprogrammeerde OP en NEER tijden



Begin  
scherm



Vasthouden tot  
OFF verschijnt



Automatische  
sturingen  
**uitgeschakeld**

### 6.2 Inschakelen van de geprogrammeerde OP en NEER tijden



Begin  
scherm



Vasthouden tot  
tijd verschijnt



Automatische  
sturingen  
**ingeschakeld**

## INSTELLINGEN VOOR CHRONIS SMART UNO EN CHRONIS SMART RTS

### 7 Speciale instellingen voor gebruik met binnen en buiten jaloezieën



Begin  
scherm



Vasthouden  
tot CLOC  
verschijnt



Kort  
indrukken



Kort  
indrukken



Kort  
indrukken



Kort  
indrukken



Kort  
indrukken



r5 knippert



Selecteer vbUS of  
vbEU mode



Vasthouden tot begin scherm verschijnt  
De instellingen zijn nu opgeslagen

**r5** : rolluik-mode

**vb:US** : US ergonomie voor jaloezieën  
- een puls is OP of NEER bevel

**vb:EU** : EU ergonomie voor jaloezieën  
- een puls is kantelen van de lamellen



## CHRONIS COMFORT UNO, IB EN RTS

### Toelichting display en functies van de toetsen

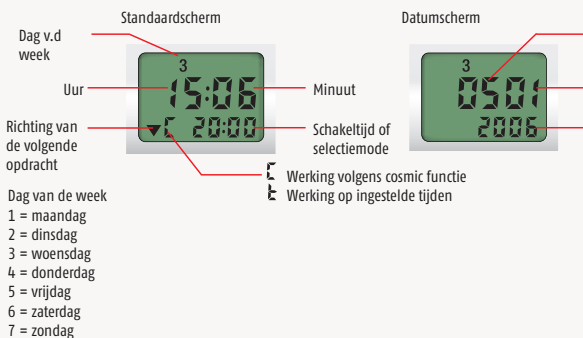
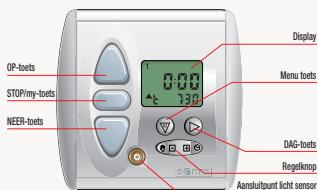

### Programmeerkeuzes



Mode waarin voor iedere dag twee tijden voor OP en twee tijden voor NEER te programmeren zijn.



SEC (Security) functie  
Functie waar de dag- en weekprogrammering wordt gebruikt en die de geprogrammeerde tijden met - 15 tot + 15 min. doet afwijken om aanwezigheid te simuleren.

## INSTELLINGEN VOOR CHRONIS COMFORT UNO, IB EN RTS

1

### Instellen huidige tijd



Begin scherm



Vasthouden tot CLOC verschijnt



Druk kort op dagtoets



De tijd knippert



Pas de tijd aan



Vasthouden tot begin scherm verschijnt

2

### Instellen huidige datum



Begin scherm



Vasthouden tot CLOC verschijnt



Kort indrukken



Kort indrukken



De dag knippert



Pas de dag aan



Kort indrukken



De maand knippert



Pas de maand aan



Kort indrukken



Het jaar knippert



Pas het jaar aan



Vasthouden tot begin scherm verschijnt  
De instellingen zijn nu opgeslagen

## INSTELLINGEN VOOR CHRONIS COMFORT UNO, IB EN RTS

### 3.1 Instellen van de eerste OP tijd op vaste tijd



Begin scherm

Vasthouden tot CLOC verschijnt

Kort indrukken

Kort indrukken

Kort indrukken

Time knippert

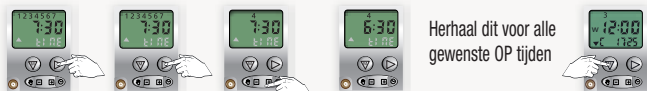

De dagen en de OP tijd knipperen

Kies een dag of alle dagen tegelijk

Pas de tijd voor OP aan

Kies eenvolgende dag met: Stel de tijd in met:

Herhaal dit voor alle gewenste OP tijden

Vasthouden tot begin scherm verschijnt. De instellingen zijn nu opgeslagen

**GEEN OP tijd gewenst op een bepaalde dag: kies dan de OFF tijd, deze komt na 23:59**

### 3.2 Instellen van de tweede OP tijd op vaste tijd



Begin scherm

Vasthouden tot CLOC verschijnt

Kort indrukken

Kort indrukken

Kort indrukken

Kort indrukken



De dagen en OFF knipperen

Kies een dag of alle dagen tegelijk

Pas de tijd voor OP aan

Kies eenvolgende dag met: Stel de tijd in met:

Herhaal dit voor alle gewenste OP tijden

Vasthouden tot begin scherm verschijnt. De instellingen zijn nu opgeslagen

**GEEN OP tijd gewenst op een bepaalde dag: kies dan de OFF tijd, deze komt na 23:59**

## INSTELLINGEN VOOR CHRONIS COMFORT UNO, IB EN RTS

### 3.3 Inschakelen COSMIC OP functie (enkel mogelijk op UP 1)



Begin scherm



Vasthouden tot CLOC verschijnt



Kort indrukken



Kort indrukken



Kort indrukken



Time knippert



Kies COSMIC functie, kort indrukken



Vasthouden tot begin scherm verschijnt  
De instellingen zijn nu opgeslagen



### 3.4 Inschakelen speling en spertijd COSMIC OP

Dit is alleen mogelijk als de COSMIC OP functie is ingeschakeld (3.3)



Begin scherm



Vasthouden tot CLOC verschijnt



Kort indrukken



Kort indrukken



Kort indrukken



COS knippert



Kort indrukken



Tijd voor speling knippert



Stel de speling in met: 

Wilt u geen spertijd invoeren, ga verder bij de laatste afbeelding.



Kort indrukken



OFF knippert, spertijd staat uit



Stel de spertijd in met: 



Kort indrukken



Vasthouden tot begin scherm verschijnt. De instellingen zijn nu opgeslagen



## INSTELLINGEN VOOR CHRONIS COMFORT UNO, IB EN RTS

3.5

Uitschakelen COSMIC OP functie



Begin  
scherm



Vasthouden tot  
CLOC verschijnt



Kort  
indrukken



Kort  
indrukken



Kort indrukken



COS knippert



Kort  
indrukken

















Time  
knippert



Vasthouden tot begin scherm  
verschijnt  
De instellingen zijn nu opgeslagen





## INSTELLINGEN VOOR CHRONIS COMFORT UNO, IB EN RTS

### 4.1 Instellen speling en spertijd COSMIC NEER tijd

					
Begin scherm	Vasthouden tot CLOC verschijnt	Kort indrukken	Kort indrukken	Kort indrukken	Kort indrukken
					
Kort indrukken	COS knippert	Kort indrukken	Tijd speling knippert	Stel de speling in met: CLOC	
					
Kort indrukken	OFF knippert, spertijd staat uit	Stel de spertijd in met: CLOC	Vasthouden tot begin scherm verschijnt. De instellingen zijn nu opgeslagen		

Wilt u geen spertijd invoeren, ga verder bij de laatste afbeelding.

### 4.2 Uitschakelen COSMIC NEER functie

					
Begin scherm	Vasthouden tot CLOC verschijnt	Kort indrukken	Kort indrukken	Kort indrukken	Kort indrukken
					
Kort indrukken	COS knippert	Kort indrukken	Time knippert	Vasthouden tot begin scherm verschijnt. De instellingen zijn nu opgeslagen	

## INSTELLINGEN VOOR CHRONIS COMFORT UNO, IB EN RTS

### 4.3 Inschakelen COSMIC NEER functie (voor de 1<sup>e</sup> NEER tijd)

					
Begin scherm	Vasthouden tot CLOC verschijnt	Kort indrukken	Kort indrukken	Kort indrukken	Kort indrukken
					
Kort indrukken	Kort indrukken	Kort indrukken	COS knippert	Vasthouden tot begin scherm verschijnt. De instellingen zijn nu opgeslagen	

### 4.4 Instellen van de 1<sup>e</sup> NEER tijd op vaste tijd

					
Begin scherm	Vasthouden tot CLOC verschijnt	Kort indrukken	Kort indrukken	Kort indrukken	Kort indrukken
					
Kort indrukken	TIME knippert	Kort indrukken	De dagen en de NEER tijd knipperen	Herhaal dit voor alle gewenste NEER tijden	Herhaal dit voor alle gewenste NEER tijden
					
Kies een dag of alle dagen tegelijk	Pas de tijd voor NEER aan	Kies eenvolgende dag met: [DAG] Stel de tijd in met: [TIJD]	Vasthouden tot begin scherm verschijnt	Vasthouden tot begin scherm verschijnt	Vasthouden tot begin scherm verschijnt
			De instellingen zijn nu opgeslagen	De instellingen zijn nu opgeslagen	De instellingen zijn nu opgeslagen

**GEEN NEER tijd gewenst op een bepaalde dag: kies dan de OFF tijd, deze komt na 23:59**

## INSTELLINGEN VOOR CHRONIS COMFORT UNO, IB EN RTS

4.5

Instellen van de tweede NEER tijd op vaste tijd



Begin scherm



Vasthouden tot CLOC verschijnt



Kort indrukken



Kort indrukken



Kort indrukken



Kort indrukken



Kort indrukken



Kort indrukken



De dagen en de OFF knippen



Kies een dag of alle dagen tegelijk



Pas de tijd voor NEER aan



Kies eenvolgende dag met:   
Stel de tijd in met: 

Herhaal dit voor alle gewenste NEER tijden



Vasthouden tot begin scherm verschijnt  
De instellingen zijn nu opgeslagen

GEEN NEER tijd gewenst op een bepaalde dag: kies dan de OFF tijd, deze komt na 23:59



## INSTELLINGEN VOOR CHRONIS COMFORT UNO, IB EN RTS

5.1

### Inschakelen Lichtsensor



Begin  
scherm



Vasthouden tot  
CLOC verschijnt



Kort  
indrukken



Kort  
indrukken



Kort  
indrukken



Kort  
indrukken



Kort indrukken



Kort  
indrukken



Kort  
indrukken



De drempelwaar-  
de zonintensiteit  
knippert



Stel de drempelwaarde  
in met: 



Indien u de zonfunctie niet wenst te gebruiken,  
stel de drempelwaande in op 00



Vasthouden tot begin scherm verschijnt  
De instellingen zijn nu opgeslagen



## INSTELLINGEN UITSLUITEND VOOR CHRONIS COMFORT UNO EN IB

### 6.1 Waarde van de schemerfunctie instellen



Begin scherm



Vasthouden tot CLOC verschijnt



Kort indrukken



Kort indrukken



Kort indrukken



Kort indrukken



Kort indrukken



Kort indrukken



Kort indrukken



Kort indrukken



Drempelwaarde schemerfunctie knippert



Stel de drempelwaarde in met:



Indien u de schermfunctie niet wenst te gebruiken, stel de schemerfunctie in op 00



Vasthouden tot begin scherm verschijnt  
De instellingen zijn nu opgeslagen

## INSTELLINGEN VOOR CHRONIS COMFORT UNO, IB EN RTS

### 7.1 Activeren van de SECURITY functie



Begin  
scherm



Vasthouden tot  
SEC verschijnt



SECurity functie  
actief

### 7.2 Uitschakelen van de SECURITY functie



Begin  
scherm



Vasthouden tot  
tijd verschijnt



Standaard functie  
actief

### 8.1 Uitschakelen van de geprogrammeerde OP en NEER tijden



Begin  
scherm



Vasthouden tot  
OFF verschijnt



Automatische sturingen  
uitgeschakeld

### 8.2 Inschakelen van de geprogrammeerde OP en NEER tijden



Begin  
scherm



Vasthouden tot  
tijd verschijnt



Automatische sturingen  
**ingeschakeld**

## INSTELLINGEN VOOR CHRONIS COMFORT UNO, IB EN RTS

9

Speciale instellingen voor gebruik met binnen en buiten jaloezieën



Begin scherm



Vasthouden tot CLOC verschijnt



Kort indrukken



Kort indrukken



Kort indrukken



Kort indrukken



Kort indrukken



Kort indrukken



Kort indrukken



Kort indrukken



r5 knippert



Selecteer vbUS of vbEU mode



Vasthouden tot begin scherm verschijnt  
De instellingen zijn nu opgeslagen

r5 : rolluik-mode

ub:US : US ergonomie voor jaloezieën  
- een puls is OP of NEER bevel

ub:EU : EU ergonomie voor jaloezieën  
- een puls is kantelen van de lamellen

## INSTELLINGEN VOOR CHRONIS COMFORT UNO, IB EN RTS

11.1

Tijdsturing naar de Tussenpositie in combinatie met de OP tijd, de NEER tijd en het "lichtcommando"



Begin  
scherm



Vasthouden tot  
CLOC verschijnt



Kort  
indrukken



Kort  
indrukken



Kort  
indrukken



Kort  
indrukken



Kort  
indrukken



Kort  
indrukken



Kort  
indrukken



Kort  
indrukken



Kort indrukken



UP 1  
knippert



Wenst u bij dit bevel het product naar de tussenpositie te sturen,

Druk kort op  zoniet ga verder



Kort  
indrukken



Wenst u bij dit bevel het product naar de tussenpositie te sturen,

Druk kort op  zoniet ga verder



Kort  
indrukken

## INSTELLINGEN VOOR CHRONIS COMFORT UNO, IB EN RTS



Wenst u bij dit bevel het product naar de tussenpositie te sturen,

Druk kort op zoniet ga verder



Kort  
indrukken



Wenst u bij dit bevel het product naar de tussenpositie te sturen,

Druk kort op zoniet ga verder



Kort  
indrukken



Wenst u bij dit bevel het product naar de tussenpositie te sturen,

Druk kort op zoniet ga verder



Kort  
indrukken



IP staat aan.  
Linksonder ziet u het aantal  
bevelen die het product naar  
de tussenpositie stuurt.



Vasthouden tot begin scherm verschijnt  
De instellingen zijn nu opgeslagen

## TELIS COMPOSIO

### Batterijen aanbrengen

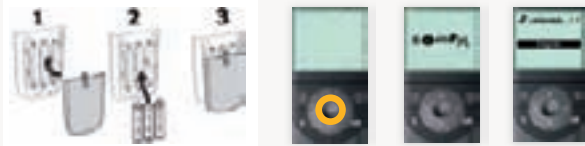

### Keuze van de taal

- Selecteer de taal met de pijltjes links en rechts.
- Bevestig uw keuze met OK

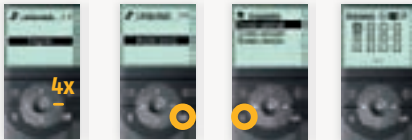

### Benoemen kanaal : geef zelf een naam aan het kanaal (naam ingeven)

- Je kan een eigen gekozen naam geven aan elk kanaal (maximaal 12 karakters).
- De verschillende kanalen staan gegroepeerd in 4 kolommen van 3 kanalen. Indien je meer dan 12 kanalen gebruikt, moet eerst de grootte van het rooster aangepast worden (zie pagina 94).

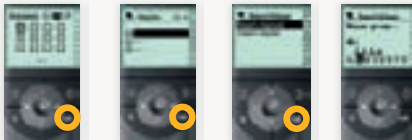

Zie verder  
pagina 91

### Benoemen kanaal : kies een naam uit de voorgeprogrammeerde lijst (naam kiezen)

In deze lijst staan volgende namen voorgeprogrammeerd:

Huis	Etage	Kamer	Slaapkamer	Keuken	
Zitkamer	Woonkamer	Verlichting	Scherm	Garage	Toegangshek

Zie verder pagina 92

## TELIS COMPOSIO

Benoemen kanaal : geef zelf een naam aan het kanaal (naam ingeven)

- Geef zelf een naam aan het kanaal

Voorbeeld : Bureau

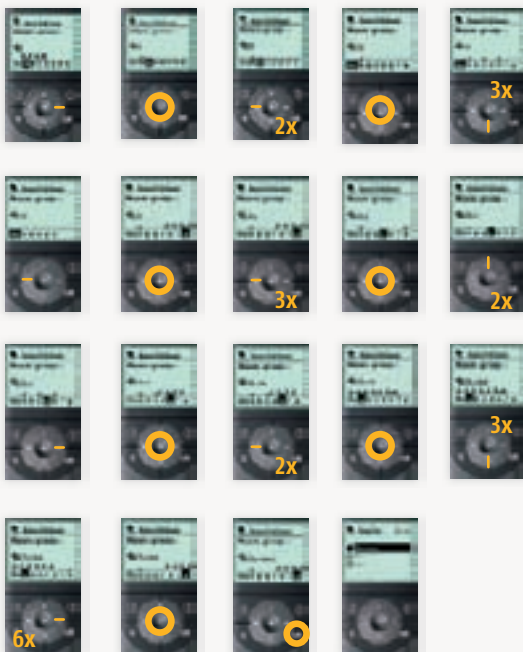

Kies een blanco lijn en begin opnieuw om een tweede kanaal te benoemen.

Indien alle kanalen benoemd zijn, ga over tot het programmeren van de kanalen (zie pagina 93).

Indien er meer dan 12 kanalen nodig zijn, moet eerst de grootte van het rooster aangepast worden (zie pagina 94).



## TELIS COMPOSIO

**Benoemen kanaal : kies een naam uit de voorgeprogrammeerde lijst (naam kiezen)**

- Kies een blanco kanaal, hetzij op dezelfde pagina, hetzij op een andere pagina.  
Bevestig met OK.

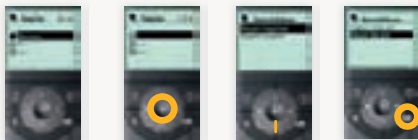

- Kies een voorgeprogrammeerde naam voor de groep  
Voorbeeld : Slaapkamer

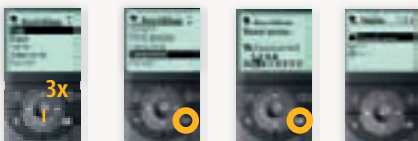

- Kies een blanco lijn en begin opnieuw om een tweede kanaal te benoemen.
- Indien alle kanalen benoemd zijn, ga over tot het programmeren van de kanalen (zie pagina 93).
- Indien er meer dan 12 kanalen nodig zijn, moet eerst de grootte van het rooster aangepast worden (zie pagina 94).

## TELIS COMPOSIO

### De zender programmeren

Wanneer alle kanalen benoemd zijn, keer terug naar het basisscherm:

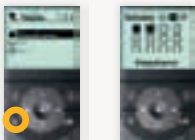

- Werk ontvanger per ontvanger.
- Programmeer de Telis Composio.
  - Open het geheugen van een ontvanger met een reeds geprogrammeerde zender
  - Programmeer een kanaal (slaapkamer) van de Telis Composio op deze ontvanger.



- Herhaal dit voor alle andere kanalen die op deze ontvanger moeten geprogrammeerd worden.
- Doe hetzelfde voor alle ontvangers die door de Telis Composio bediend moeten worden.

## TELIS COMPOSIO

### Rooster aanpassen

Wanneer er twaalf kanalen benoemd zijn, moet men de grootte van het rooster aanpassen vooraleer men nieuwe kanalen kan benoemen:

Keer terug naar het basisscherm door een aantal keren op C te drukken.

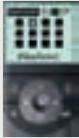

Ga naar het menu systeem – instellingen – omvang rooster

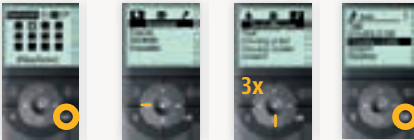

Selecteer 20 groepen, bevestig en keer terug naar het basisscherm,

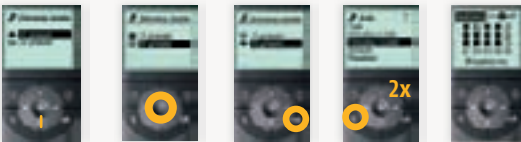

Je kan nu weer blanco vakjes selecteren voor het benoemen van nieuwe kanalen.

# TUSSENPOSITIE

(CHRONIS UNO, SOLIRIS UNO, UNIVERSAL RECEIVER RTS, CENTRALIS INDOOR RTS, CENTRALIS UNO RTS, SOLUS RADIO KIT)

1

Afstellen van de tussenpositie van boven uit

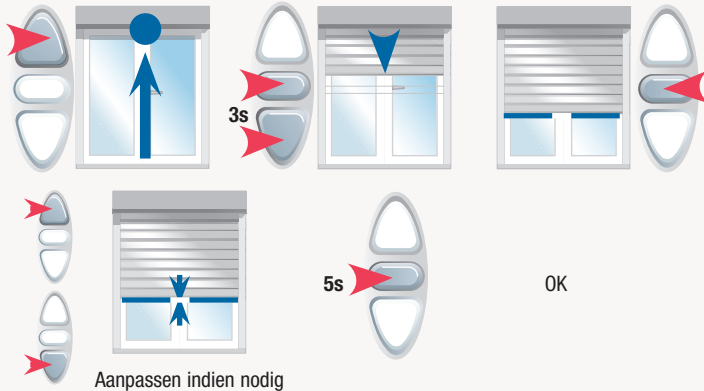

2

Afstellen van de tussenpositie van onder uit

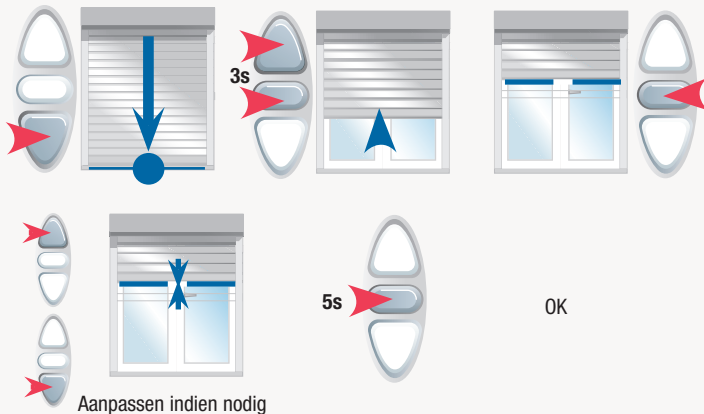

## TUSSENPOSITIE

(CHRONIS UNO SOLUS RK, SOLIRIS UNO, UNIVERSAL RECEIVER RTS,  
CENTRALIS INDOOR RTS, CENTRALIS UNO RTS)

3

Wissen van een tussenpositie



Of



10s



Ga naar de  
tussenpositie

4

Werking tussenpositie



Of



Kort

# BEDRADINGSSCHEMA

Centralis IB en Centralis Uno IB

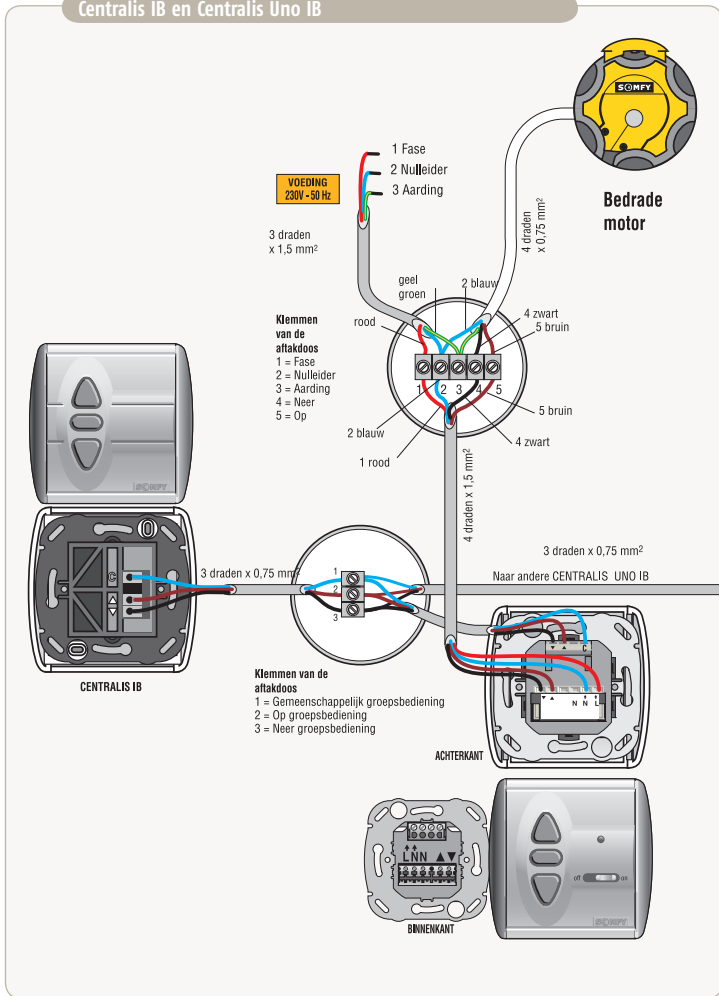

# BEDRADINGSSCHEMA

Centralis Uno IB en Chronis IB

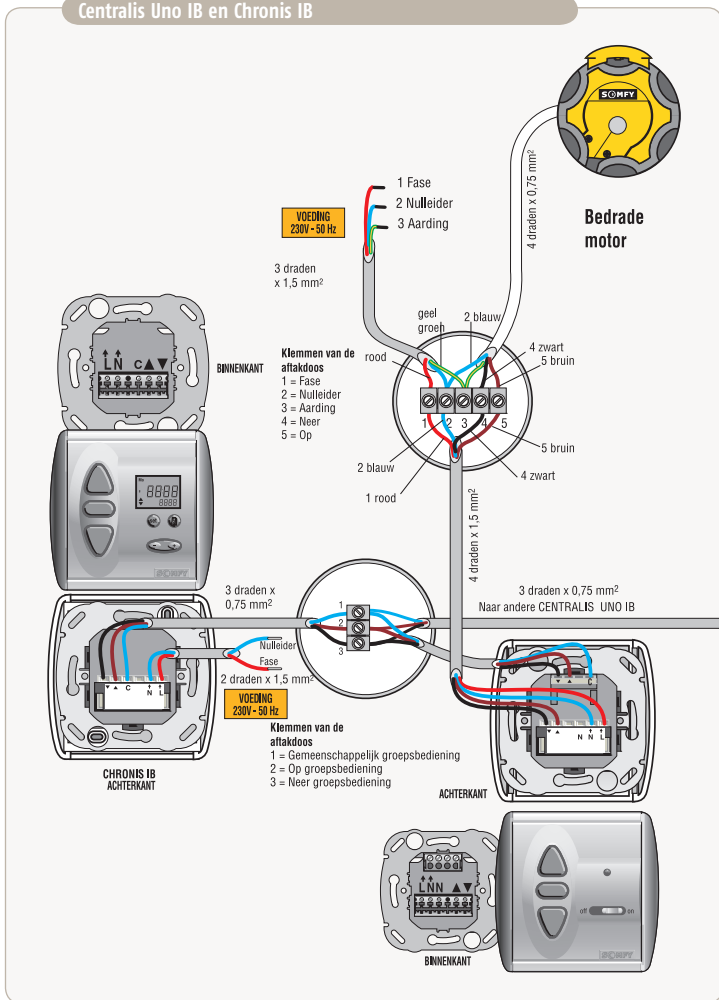

# BEDRADINGSSCHEMA

Centralis Uno IB en Soliris IB

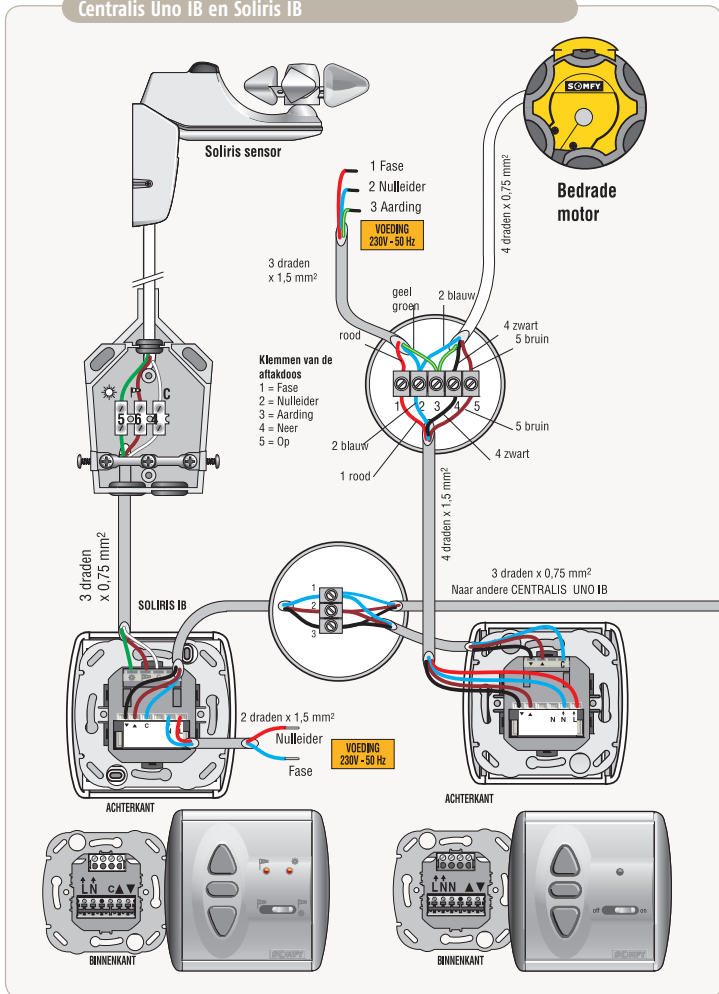



## PROGRAMMATIE VAN DE EERSTE ZENDER OP SOLUS RK

### 1 Neem de controle over de motor

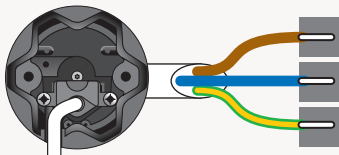

Slechts 1 motor tegelijk onder spanning

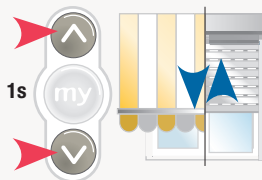

Korte beweging

### 2 Controleer de draairichting



OK → volgende pagina

### 3 Verander de draairichting - indien nodig



Korte beweging

### 4 Stroomonderbreking



Onderbreking 2s mini

## PROGRAMMATIE VAN DE EERSTE ZENDER OP SOLUS RK

5

Controle nemen over de motor

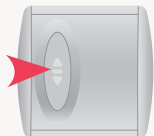

Kort indrukken (0,5 sec.)



Korte beweging  
→ Ok

6

Programmeren van de zender

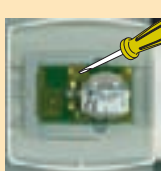

< 1s

Maak contact tussen Prog en batterij



Korte beweging  
→ Ok

## AFSTELLEN SOLUS PA EN SOLUS RK MOTOR

**1** De draairichting bepaalt welke draaiftift gebruikt moet worden

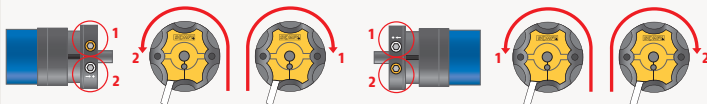

**2** Afstellen onderste eindpunt : 3 mogelijkheden



**3** Onderste eindpunt is te hoog



**4** Onderste eindpunt is te laag



## AFSTELLEN SOLUS PA EN SOLUS RK MOTOR

### 5 Afstellen bovenste eindpunt : 3 mogelijkheden



De motor stopt voor het bovenste eindpunt

→ 6

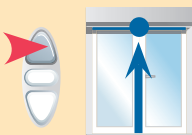

De motor stopt op de juiste positie

→ 8

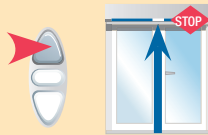

De motor stopt na het bovenste eindpunt

→ 7

### 6 Bovenste eindpunt is te laag



Ok → 8

### 7 Bovenste eindpunt is te hoog



Terug naar 5

### 8 Test



## DE MOTOR SOLUS RADIO KIT IN FABRIJKSSTAND ZETTEN

### 1 Open het geheugen met een dubbele spanningonderbreking

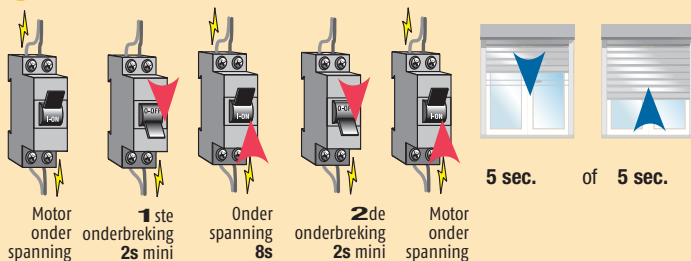

Enkel een dubbele spanningonderbreking uitvoeren op de betrokken motor.

### Moet gebeuren met een geprogrammeerde zender

### 2 Zet de motor terug in fabrieksstand

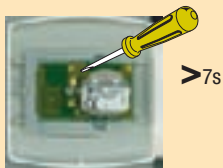

Contact tussen Prog en batterij



Korte beweging na 7 sec.

→ Ok

## PROGRAMMATIE VAN DE EERSTE ZENDER OP PLATINE RTS EN SLIM RECEIVER

### 1 Neem de controle over de motor

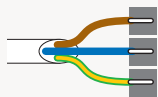

Eén enkele Platine  
onder spanning

1 sec.



Tesamen



Korte beweging

### 2 Controleer de draairichting



Ok

→ 4



Niet ok

→ 3

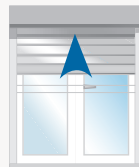

### 3 Pas de draairichting aan - indien nodig

Voor Platine RTS en Universal Slim Receiver

Voor Modulis Slim Receiver



5 sec.

Korte beweging → Ok



Verwissel de bruine en zwarte motorkabel

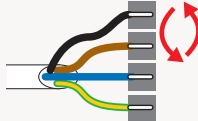

### 4 Programmeer de zender op de motor



Achterkant Telis

1s



Korte beweging → Ok

## PLATINE RTS EN SLIM RECEIVERS IN FABRIJKSSTAND ZETTEN

### 1 Open het geheugen met een dubbele spanningsonderbreking

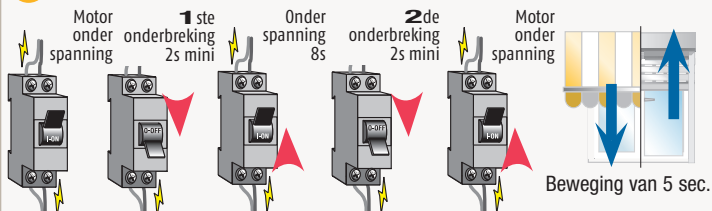

**Alleen een dubbele spanningsonderbreking uitvoeren op de betrokken ontvanger**

### 2 Zet de ontvanger in het fabrieksstand

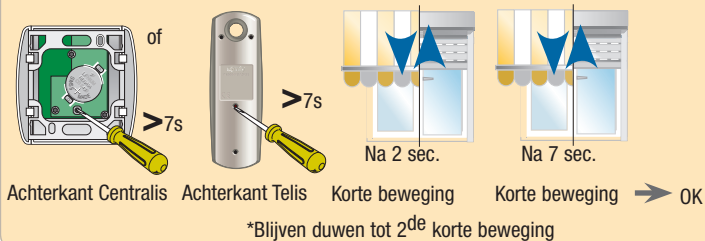

## HET CODEKLAVIER PROGRAMMEREN OP EEN ONTVANGER

### Het codeklavier opstarten



### 1 Open het geheugen van de ontvanger

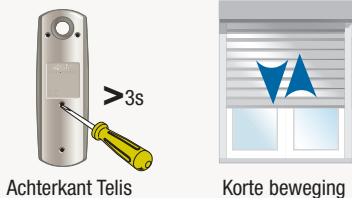

### 2 Ontgrendel het codeklavier

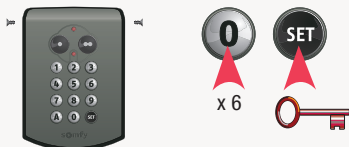

### 3 Druk op PROG en vervolgens op één van beide toetsen





## DE HOOFDCODE WIJZIGEN

### 1 Ontgrendel het codeklavier en open het geheugen

- De fabriekscode is altijd = 000000
- Een code moet minstens 4 karakters bevatten, maximum 6.

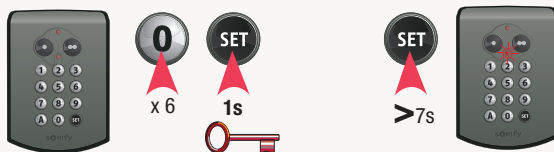

### 2 Voer de nieuwe hoofdcodes in en bevestig hem

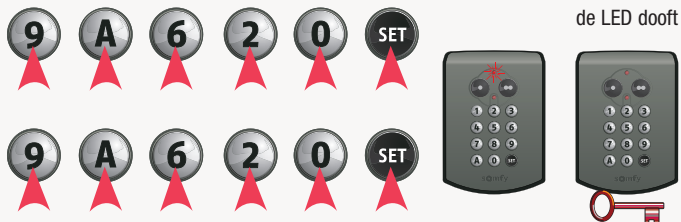

### 3 De hoofdcodes vergeten

- Het codeklavier opnieuw in fabrieksstand zetten (Hoofdcodes terug 000000).
- Alle codes worden gewist en de motor kan niet meer bediend worden.
- Het codeklavier moet opnieuw geprogrammeerd worden.



## EXTRA CODES

Een code toevoegen: code 2196 voor kanaal 1

1 Ontgrendel het codeklavier en open het geheugen



2 Voer de code voor kanaal 1 in en bevestig hem



## ALLE CODES WISSEN

1 Ontgrendel het codeklavier en open het geheugen



2 Wis alle codes behalve de hoofdcode



## ÉÉN CODE WISSEN

Bijvoorbeeld: code 2196 voor kanaal 1

1

Ontgrendel het codeklavier en open het geheugen



2

Wis code 2196 van kanaal 1

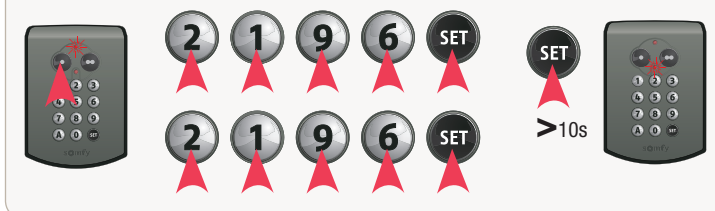

Voor alle  
technische vragen :

**Somfy Customer**

**Support**

**T + 32 (0) 2 712 07 77**



**SOMFY Belux**

Mercuriusstraat 19

B 1930 Zaventem

T +32 (0) 2 712 07 70

F +32 (0) 2 725 01 77

[www.somfy.be](http://www.somfy.be)

[info@somfy.be](mailto:info@somfy.be)

**Waarde: 10 €**

**somfy**

SY-BE-HBX-HNDBRENS-0907-NL/01